

DE BEERS GROUP
INSTITUTE OF DIAMONDS



GRADING STANDARDS

VERSION 1.6 – MAY 2019

Contents

| | | |
|----------|--|-----------|
| 1 | Introduction: the science behind the magic | 2 |
| 1.1 | De Beers Group Institute of Diamonds grading | 3 |
| 1.1.1 | Carat | 3 |
| 1.1.2 | Colour | 3 |
| 1.1.3 | Clarity | 3 |
| 1.1.4 | Cut Grade | 3 |
| 1.2 | De Beers Group Institute of Diamonds production control software | 4 |
| 1.3 | Grading integrity controls | 4 |
| 2 | De Beers Group Institute of Diamonds grading methods | 5 |
| 2.1.1 | Introduction | 5 |
| 2.2 | Colour grading | 7 |
| 2.3 | Clarity grading | 10 |
| 2.4 | Cut grade | 30 |
| 2.4.1 | Proportions | 30 |
| 2.4.2 | Finish grading | 40 |
| 3 | De Beers Group Institute of Diamonds and laser | 57 |
| 3.1.1 | Laser and clarity enhancements | 57 |
| 3.1.2 | Penetrative, internal laser accidents | 59 |
| 4 | Diamond Grading Report | 60 |
| 4.1.1 | The 4Cs of diamonds | 60 |
| 4.1.2 | Grading summary | 60 |
| 5 | Clarity treatments | 62 |
| 5.1.1 | KM | 62 |
| 5.1.2 | Fracture filling | 63 |
| 5.1.3 | Laser drilling | 64 |
| 5.1.4 | Coating | 65 |
| 6 | Summary | 66 |
| 7 | Change log | 67 |
| | Appendix: | 68 |
| | Table, crown and pavilion angle proportions charts | 68 |

1 Introduction: the science behind the magic

At De Beers Group Institute of Diamonds (formerly International Institute of Diamond Grading and Research), we understand the science of diamonds. De Beers Group Institute of Diamonds was established by De Beers Group, the organisation most closely associated with both the mystique and science of diamonds. De Beers Group Institute of Diamonds builds on De Beers' unrivalled knowledge of diamonds. Our mission is to provide premium grading services and through our technology arm: De Beers Group Technology, proprietary diamond detection equipment to the diamond industry.

At De Beers Group Institute of Diamonds, our graders are passionately committed to their work: constantly using and researching the very latest in diamond grading technology. It is this personal touch – complemented by our advanced bespoke processes and technology – that ensures the highest levels of accuracy and consistency.

Every diamond that goes through one of our three laboratories, run by world-class diamond experts in Antwerp, Maidenhead and Surat, benefits from the use of De Beers' proprietary equipment that enables the most precise grading and assessment for polished diamonds.

De Beers Group Institute of Diamonds grades only those diamonds compliant with the United Nations' mandated World Diamond Council Kimberley Process. This exclusivity inspires confidence among diamantaires and ultimately, the consumers they serve. It is one of the few grading institutes solely devoted to diamonds.

1.1 Institute of Diamonds grading

1.1.1 Carat

De Beers Group Institute of Diamonds issues grading reports for unset, natural diamonds weighing at least 0.10 carat.

Following the industry norm, a De Beers Group Institute of Diamonds grading report records the weight of a diamond to 2 decimal places. However, for security purposes, De Beers Group Institute of Diamonds receives and dispatches every diamond by weighing it to 6 decimal places.

De Beers Group Institute of Diamonds uses a 0.0015 carat weight rounding up factor. For example a diamond weighing 0.3484 carat is reported 0.34 carat. One weighing 0.3485 is reported 0.35 carat.

1.1.2 Colour

De Beers Group Institute of Diamonds accepts and grades natural, untreated diamonds of all colours.

1.1.3 Clarity

De Beers Group Institute of Diamonds grades diamond clarities from Flawless through I-3, adhering to internationally accepted standards and terminology for each grade. Aided by the microscope, graders finish Clarity, Polish and Symmetry grading with a 10X loupe.

1.1.4 Cut Grade

De Beers Group Institute of Diamonds assesses cut grade on round brilliants from Excellent to Poor aligned with the more strict internationally recognized standards. The factors which determine a diamond's Cut Grade are its measured Proportions and its Finish Grades of Polish and Symmetry.

1.2 De Beers Group Institute of Diamonds production control software

The production control software (PCS) has been written specifically for De Beers Group Institute of Diamonds' processes. It has the capability to anonymously control the flow of diamonds submitted for grading. The audit trail recorded for each diamond includes every step of the grading process whilst in stock and when issued to each grader for a task to be completed. All data generated at every task is also recorded in the De Beers Group Institute of Diamonds global database.

The PCS has been created to automatically control key steps of the process without user intervention. This is deliberate to remove any possibilities of corruption and favouritism. As soon as the diamond enters the process no manual intervention or knowledge of the client is possible.

1.3 Grading integrity controls

- The identity of any diamond is hidden at all times owing to De Beers Group Institute of Diamonds' policy of first repackaging all diamonds sent to De Beers Group Institute of Diamonds.
- De Beers Group Institute of Diamonds' systems ensure that any diamond's owner is completely anonymous to graders.
- All De Beers Group Institute of Diamonds' grading personnel remain inaccessible to any diamantaire requesting grading services.
- Diamonds are allocated to individuals at random using De Beers Group Institute of Diamonds' stock control system.
- System rules and constraints guarantee each grading stage on a given diamond is always conducted by a different grader.
- Every diamond is measured using proprietary grading equipment developed by De Beers Group Technology providing a scientific, unbiased measurement of the diamond's colour.
- De Beers Group Institute of Diamonds grading results cannot be viewed on the system by any personnel within the laboratory until the diamond has completely finished the grading processes and final results have been committed.
- Technical analysis is conducted outside of De Beers Group Institute of Diamonds to identify any unusual patterns or grading behaviour.
- To comply with The Pipeline Integrity Standard (developed and authorised by the British Standards Institute) all De Beers Group Institute of Diamonds facilities are regularly audited by SGS, our third party verifier for integrity.

2 De Beers Group Institute of Diamonds grading methods

2.1.1 Introduction

De Beers Group Institute of Diamonds has developed a grading method used to assess each unique polished diamond's individual qualities and features. It measures against universally accepted standards with absolute focus on consistency and repeatability over time.

Graders make optimal use of equipment that has been developed and standardised throughout the diamond industry. Technology developed over many years by De Beers Group Technology including colour machines and synthetic and treatment detection instruments are also included.

De Beers Group Institute of Diamonds uses its own extensive photograph reference library of internal and surface features in identification of characteristics. The De Beers Group Institute of Diamonds grader also has access to clarity masters for comparison of Clarity, Proportions, Polish and Symmetry. This includes complete D to Y-Z and Fancy Yellow colour masters and master fluorescence comparison sets.

Standardised procedures and rules have been developed for each phase of grading in order to enforce consistency of the final grade. A sub-grade system is employed to make a grader's assessment more precise.

The summarization of the 4Cs are presented in the De Beers Group Institute of Diamonds grading report. This includes Clarity with a graphic plot and/or a description of those features, Cut (made up of Proportions, Polish and Symmetry) and the Colour plus Fluorescence as well as the diamond's Carat weight.

The security, safety and integrity of the data for every diamond is paramount. Each grader must follow strictly defined rules. All De Beers Group Institute of Diamonds' Master Clarity, Colour and Fluorescence comparison diamonds are table inscribed to further assure security.

2.1.1.1 Sub-grade system

In the interest of accuracy and production De Beers Group Institute of Diamonds uses a system of assigning sub-grades to all graders' decisions in colour, clarity, polish and symmetry.

In grading diamonds there are many varied examples of a given grade including a few that are borderline to the next grade up or down. Recognising this graders use a 1 – 5 numbering system to record the position of the diamond within the grade.

Sub-grades:

- 1 The diamond is top of the grade and borders the next grade up.
- 2 The diamond is top of grade.
- 3 The diamond is a middle of grade.
- 4 The diamond is bottom of grade.
- 5 The diamond is bottom of grade and borders the next grade down.

A grader must not only choose a grade but further justify that choice by ranking it with others that he's encountered. This serves to focus the objective grading decision process by a degree of five. Note that sub-grades are treated somewhat differently for Clarity and Colour.

Clarity, polish and symmetry sub-grades 1 and 5 are considered as borderlines and not bands. These two sub-grades alert the final grader that a grade involving a difficult decision has been made. Use of a 1 or 5 sub-grade can refer the grading diamond to a further, more senior grader. Sub-grades 2 and 4 are bands at the top or bottom of a grade while a 3 denotes the broad middle and would not be considered anything but that grade.

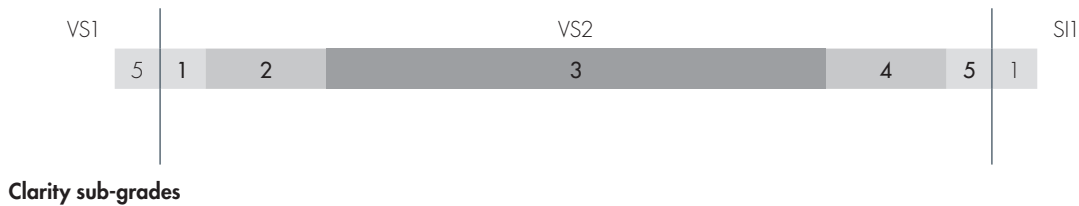

As De Beers Group Institute of Diamonds employs the De Beers R&D Colorimeter, colour sub-grades are more quantified than clarity sub-grades and form measurable bands. Colour sub-grade 1 is the top 1/8 of a colour. Sub-grade 2 is the next 1/8 down. Sub-grade 3 is the middle of a colour consisting of half of its total range. Sub-grade 4 is the next 1/8 down and sub-grade 5 is the last 1/8 of a given colour.

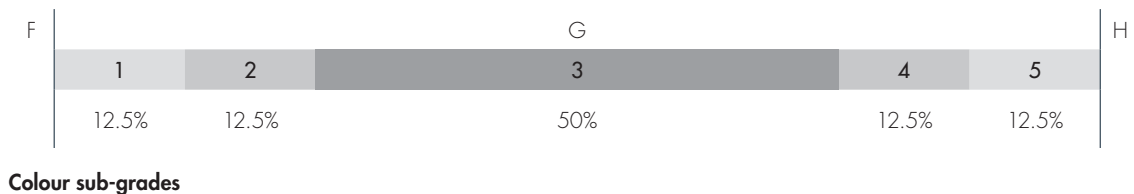

2.1.1.2 Treatments and synthetics

De Beers Group Institute of Diamonds grades only natural, non-enhanced, untreated diamonds. To eliminate any diamond suspected of clarity or colour enhancing treatments De Beers Group Institute of Diamonds employs the latest detecting instruments including but not limited to DiamondView™, DiamondSure™ and DiamondPlus™ developed by De Beers Group Technology.

Graders are alerted to possible treatments that are detected optically such as laser drilling, fracture filling and coatings. Proofs or remnants of laser rough division or girdle marking, however, are not excluded and are considered in grading a diamond's polish and symmetry.

2.2 Colour grading

De Beers Group Institute of Diamonds colour grading incorporates colour master sets that have been developed using universally accepted standards from leading international grading laboratories and consist of borderline master diamonds D/E, E/F, F/G, G/H, H/I, I/J, J/K, K/L, L/M, M/N, O-P/Q-R, Q-R/S-T, S-T/U-V, U-V/W-X, W-X/Y-Z, Fancy Light Yellow, Fancy Yellow, Fancy Intense Yellow and Fancy Vivid Yellow. Master colour sets have been duplicated precisely using the De Beers R&D Colorimeter. Thus all De Beers Group Institute of Diamonds graders are using identical master colour sets. These sets give the grader defined boundaries for the yellow saturation of a diamond to assign a colour grade based upon the universally accepted letter grades.

De Beers Group Institute of Diamonds grades all colours using the single letter grade system D through N, double letter grades from O-P through Y-Z in yellow, and all fancy colours. G through M equivalents of other hues are described as Faint; N through Q-R equivalents are Very Light, and S-T through Y-Z are called Light, such as Light Yellowish Green.

| MASTER STONE | D/E | | | | E/F | | | | F/G | | | | G/H | | | | H/I | | | | I/J | | | | | | | | |
|------------------|-----|---|---|---|-----|---|---|---|-----|---|---|---|-----|---|---|---|-----|---|---|---|-----|---|---|---|---|---|---|---|---|
| COLOUR SUB-GRADE | D | | | | E | | | | F | | | | G | | | | H | | | | I | | | | | | | | |
| | 2 | 3 | 4 | 5 | 1 | 2 | 3 | 4 | 5 | 1 | 2 | 3 | 4 | 5 | 1 | 2 | 3 | 4 | 5 | 1 | 2 | 3 | 4 | 5 | 1 | 2 | 3 | 4 | 5 |

De Beers Group Institute of Diamonds Colour Masters

Each master colour is the last colour allowable of the higher of the two borderline colours. Thus the E/F Master Stone is an E colour with sub-grade 5 or E (5) and the H/I Master can also be described as an H (5).

Colour grading a diamond close to G and H colours, a grader uses the G/H Master. If the production diamond shows less yellow than the Master it is graded G colour. If the production diamond shows more yellow, it is graded H colour. A production diamond exactly matching the Master G/H sample is graded the higher colour G or G (5).

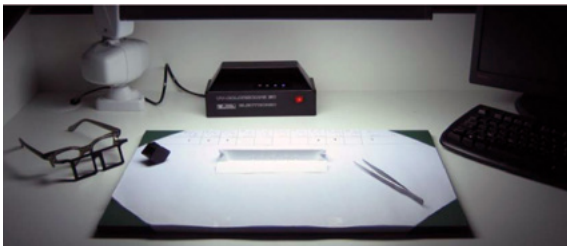

Colour grading bench

All diamonds are colour graded in a dark environment, with no daylight and no overhead lighting. Graders use standard Dazor™ Diamond Light with two 15 watt tubes of F15T8-D Daylight.

As a polished diamond concentrates its true colour around the culet, graders view the diamond through the pavilion (ignoring girdle and crown) while table down in a white colouring card.



Colour grading

Colour grading is conducted with the De Beers R&D Colorimeter, which measures and records colour grades with sub-grades, and depending upon grader agreement or size of the diamond 2 or 3 human graders also perform the same task.

2.2.1.1 Fancy colours

Diamonds of Yellow, Brown and Grey hues follow the D to Y-Z letter scale without mention of these colours. Other diamonds of recognized colours of Orange, Red, Purple, Pink, Green, Blue and Violet can be described as Faint, Very Light and Light depending upon the saturation of their colours. Diamonds of saturations equivalent to yellow G through M are graded Faint, such as Faint Pink. Diamonds of saturations equivalent to N through Q-R colours are graded Very Light, like Very Light Orange. Saturations from S-T through Y-Z are called Light, such as Light Blue.

| D - Z YELLOW EQUIVALENT | | | | | | | | | | | | | | | | | |
|-------------------------|---|---|-------|---|---|---|---|---|------------|---|-----|-------|-----|-----|-----|-----|-------|
| D | E | F | G | H | I | J | K | L | M | N | O-P | Q-R | S-T | U-V | W-X | Y-Z | FANCY |
| BROWN | | | | | | | | | | | | | | | | | |
| GREY | | | | | | | | | | | | | | | | | |
| OTHER HUES | | | FAINT | | | | | | VERY LIGHT | | | LIGHT | | | | | |

Colour Equivalents to the D to Y-Z Yellow range

As all diamonds' saturations increase past the yellow Y-Z, they are described as Fancy Light, Fancy, Fancy Intense and Fancy Vivid. Fancy Deep and Fancy Dark have increased saturation and darker tones.

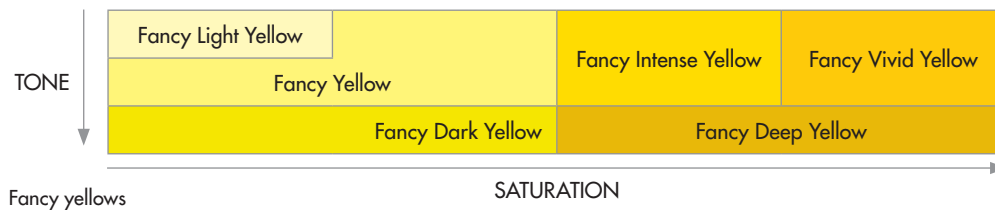

Fancy yellows

Very few fancy colour diamonds exhibit a pure hue such as red or blue. Most are better described with a modifier such as greenish yellow or orangey brown. De Beers Group Institute of Diamonds limits colour grades to a maximum of 4 terms such as Fancy Vivid Purplish Red.

Standard round brilliant diamonds are designed for the maximum return of reflected and refracted white light and tend to mask their body colours. Some fancy shapes, particularly radiants and cushions cut with deeper pavilions, can actually enhance their colours. With this in mind De Beers Group Institute of Diamonds grades potential fancy colours viewing face up as well as through the pavilion in normal D through Y-Z colour grading. A diamond of W-X colour when viewed through the pavilion may be in fact graded Fancy Light Yellow because of its face up appearance.

| Yellow | Orange | Red | Purple | Pink | Brown | Green | Blue | Violet | Grey |
|----------------------------------|--|-------------------------|-----------------------------|-----------------------------------|--|---------------------------------|----------------|--------|------|
| Brown Orange Green Grey | Red Brown Pink Yellow Grey | Purple Brown Grey | Blue Pink Red Grey | Purple Orange Brown Grey | Orange Yellow Pink Red Purple Green | Blue Yellow Brown Grey | Violet Grey | Grey | |

Fancy colours and their modifiers

2.2.1.2 Fluorescence

De Beers Group Institute of Diamonds grades fluorescence in terms of intensity only under long wave ultraviolet light. Fluorescence is graded at the colour station using the standard System Eickhorst™ UV-Colorscope EC, which incorporates a double 9 watt tube 366 nm black light.



Fluorescence masters with production diamond

De Beers Group Institute of Diamonds uses a 4 diamond Master Set for five grades of Fluorescence.

| MASTER | NEG/FNT | FNT/MED | MED/STR | STR/V STR | |
|-----------|------------|---------|---------|-----------|-------------|
| INTENSITY | Negligible | Faint | Medium | Strong | Very Strong |

Fluorescence masters

Diamonds showing fluorescence of the same intensity as the master are graded the lesser intensity. Thus a diamond with the same intensity of fluorescence as the Faint/Medium master is graded Faint.

As a further guide for graders, diamonds graded from Negligent through Medium show no indication of fluorescence under the loupe. Very Strong blue fluorescent diamonds exhibit a very distinctive purplish appearance at 10X. Very rarely diamonds with very strong fluorescence may appear oily or hazy. As their brilliance is diminished these diamonds may have lower clarity grades.

As a security measure, all colour and fluorescent masters are table inscribed.

2.3 Clarity grading

De Beers Group Institute of Diamonds has developed accurate and efficient procedures in clarity grading which also incorporate finish assessments of polish and symmetry. These comprise another three grades which, along with colour and fluorescence complete the five human decisions made on every De Beers Group Institute of Diamonds graded diamond. Graders must offer justification for all assessments in clarity, polish and symmetry grading. This is best provided in plotting appropriate symbols for features observed in or upon a polished diamond on a plot template. A grade most often corresponds visually to its graphic representation, or the number, size and location of icons on the plot diagram.

2.3.1.1 Round brilliant cut

The standard round brilliant has 57 Facets consisting of 1 table, 8 stars, and 16 upper girdle facets situated on the upper side or the crown of the diamond. 16 lower girdle facets and 8 pavilion facets are located on the bottom or pavilion side of the diamond. An additional culet facet would then total 58.

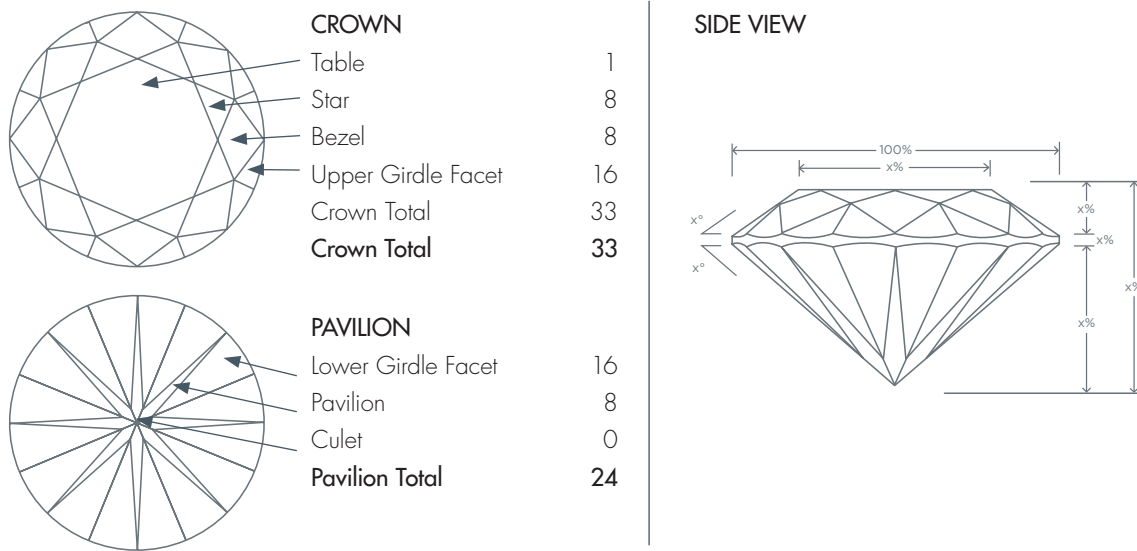

Round Brilliant Cut

2.3.1.2 Clarity features

In the interests of accuracy and simplicity, De Beers Group Institute of Diamonds graders plot or comment only upon features that serve to set a diamond's clarity grade and ignore all others. Only clarity features, grading comments, naturals and extra facets appear on the grading report's plot diagram.

Bruise ✘

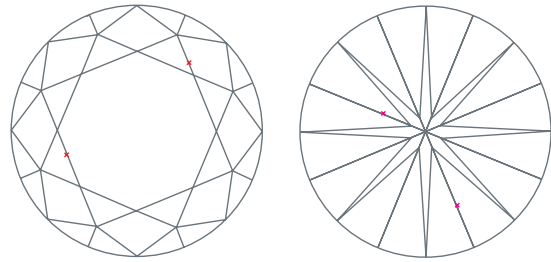
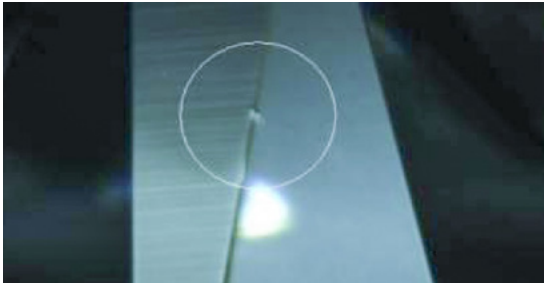

A Bruise is a nick with a feather located underneath. Often resulting from impact damage a bruise is generally located on a facet rib. Bruises are very small features, generally limited to VVS and VS1, and are irrelevant on VS2 and SI clarity diamonds.

Cavity 🌀

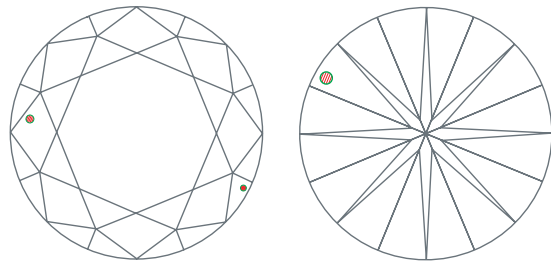
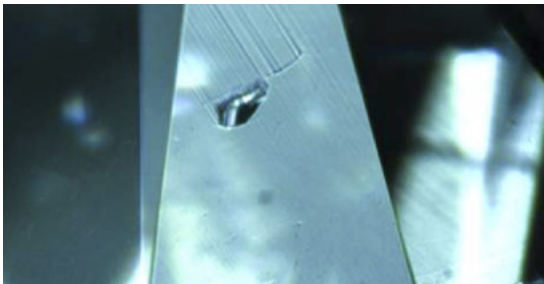

A Cavity is the hole left when an included crystal falls out during polishing, the hole left by polishing open a gas bubble, or an indented natural that is not located on a facet rib or the girdle.

Chip ^

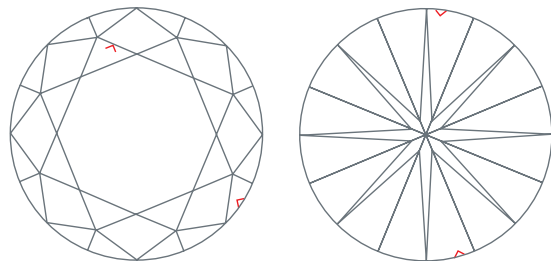
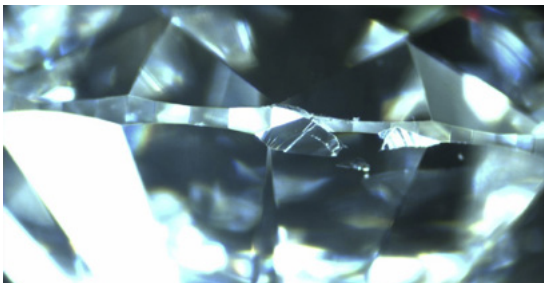

A Chip is the hole on the girdle, facet junction (rib) or culet left from serious impact damage or a feather breaking out of a polished diamond. Significantly larger than a nick, a chip is considered a clarity feature unless at the culet where it is considered in a diamond's polish grade. Appearing more like broken glass, a chip has less crystal form than an indented natural.

Cloud 

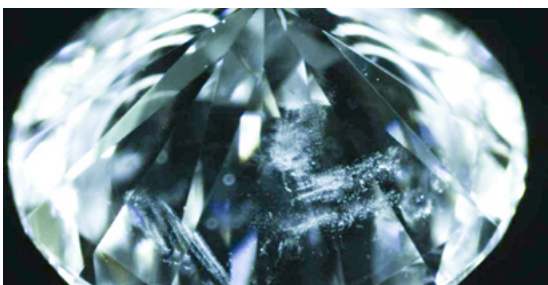

Specific Cloud

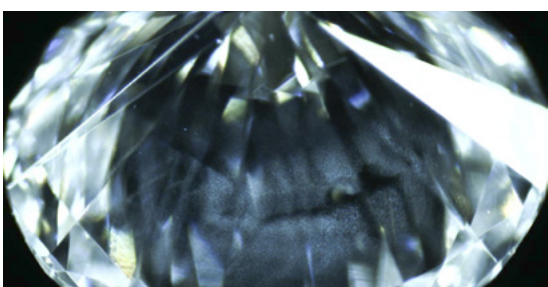
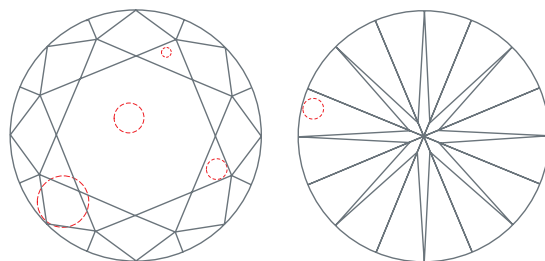

Dispersed Cloud

A Cloud is a hazy area consisting of minute inclusions or a closely arranged group of small inclusions such as pinpoints, needles or crystals. Clouds may be specific in dimension and location or they may be dispersed and take up large areas in a diamond.

Crystal 

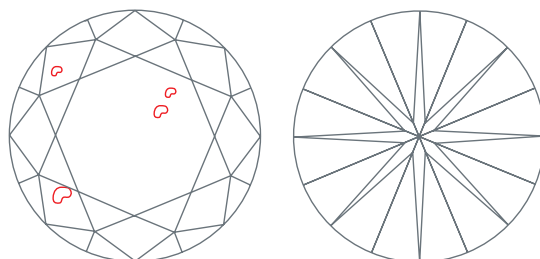
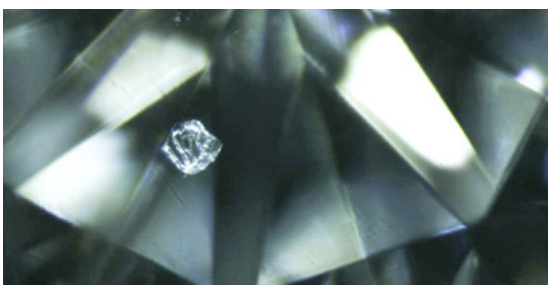

A crystal is an entirely included diamond or other mineral crystal. In plotting, De Beers Group Institute of Diamonds graders have the choice of 6 standard sizes of crystal. Use of the small crystal eliminates any grade better than VS1. A medium crystal precludes any grade better than VS2 and the large crystal precludes any grade better than SI1. Diamonds with highly contrasting crystals readily visible to the unaided eye through the pavilion against a light background may be graded I-1 and lower.

Etch Channel 

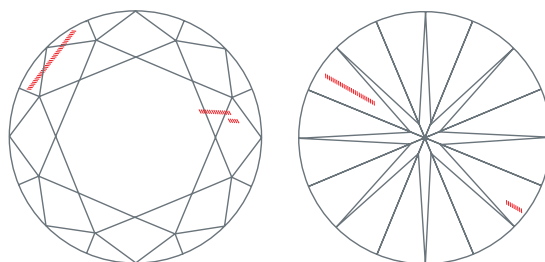
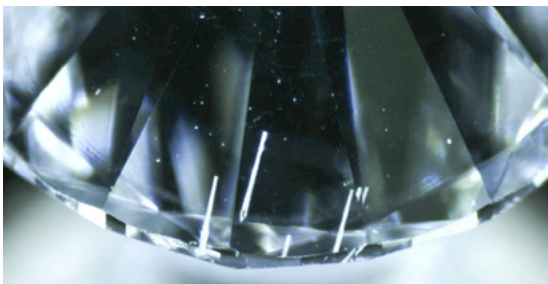

An etch channel is a linear feature and is usually the hole left over from another mineral either being burned or acid boiled out.

Feather

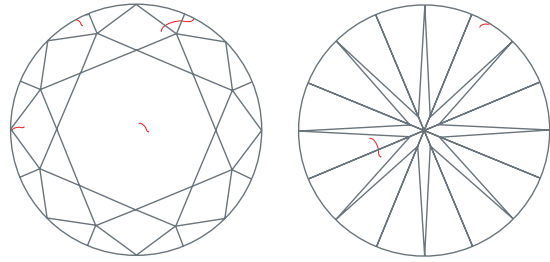
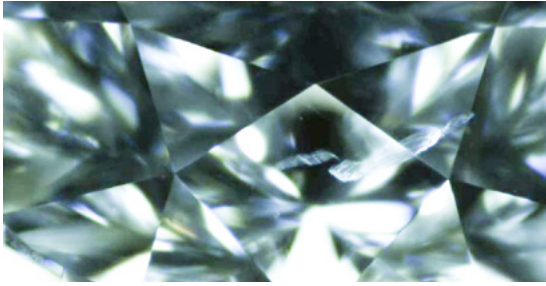

A Feather is an included fracture or crack that may or may not follow a natural cleavage direction. It may be totally included or reach the surface of the diamond and appears whitish or transparent. Allowance is made in grading VVS clarity surface feathers as having less impact upon a grade than fully included pinpoints, needles or clouds.

Grain Centre

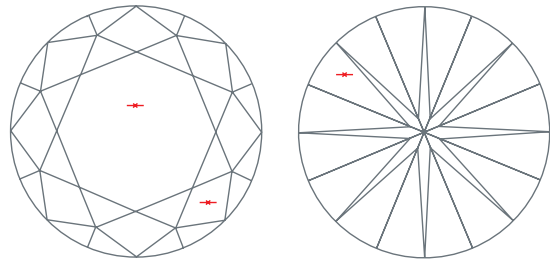
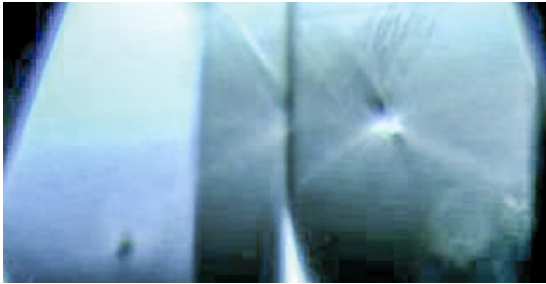

Grain Centre is a small concentration of entirely included, irregular crystal structure. This feature may sometimes form around an inclusion such as a pinpoint or small crystal.

Indented Natural

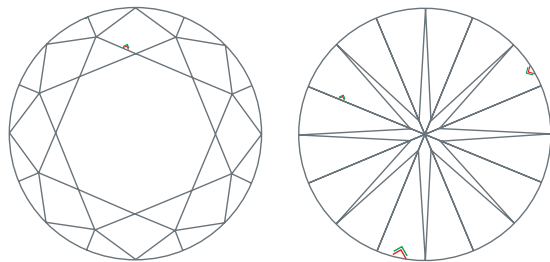
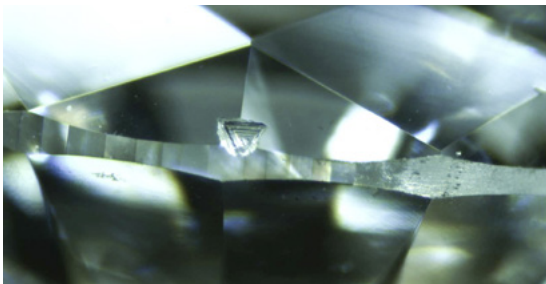

An Indented Natural is part of the original rough surface, located in or on the girdle that penetrates a polished diamond affecting its clarity grade. It is also the hole left by a knot falling out of the girdle during polishing. It is not easily removed in repolishing without significant weight loss. Naturals that can be removed by polishing an extra facet or two without disturbing a polished diamond's symmetry are not indented naturals. Large indented naturals can influence a diamond's symmetry grade.

Internal Graining

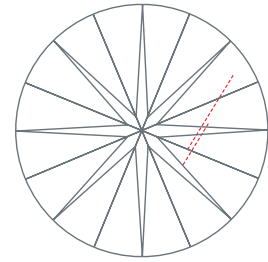
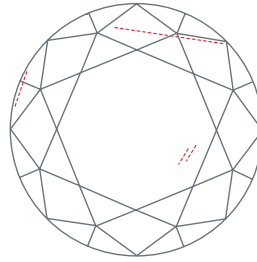
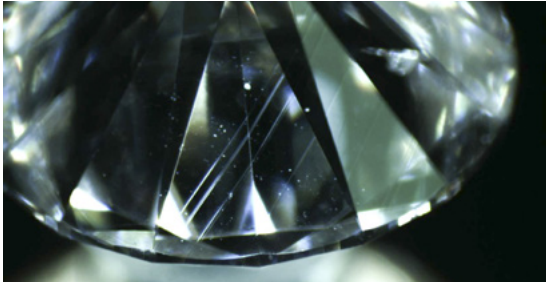

Internal Graining is an included indication of irregular crystal growth that can be streaky, reflective or may also take the form of brown or whitish bands. Graders plot coloured or reflective internal graining when used in grade setting. Dispersed graining may set a diamond's grade without plotting in the case of *Grade based upon graining*. In cases where graining forms part of a diamond's grade setting features, the comment *Graining is present* is used.

Internal Laser Manufacturing Remnant

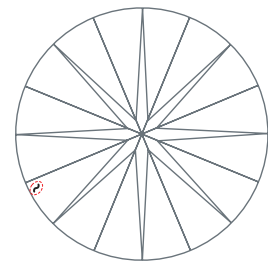
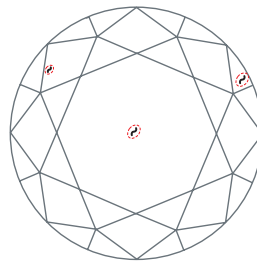
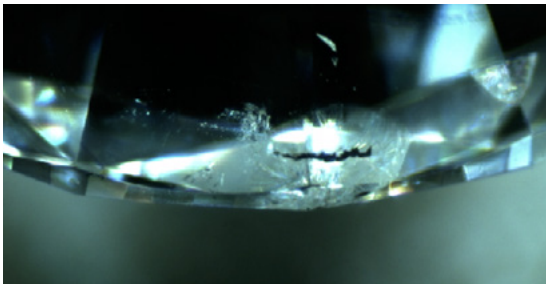

Lasers are often used in the diamond manufacturing process. When reflections cause a laser to focus on a diamond's interior rather its surface damage can occur. These internal laser remnants are graded in clarity in the same way as crystals or other, similar features.

Knot

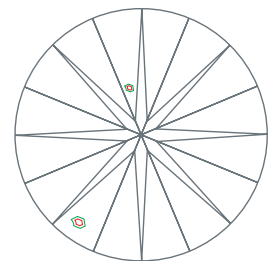
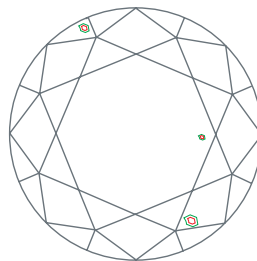
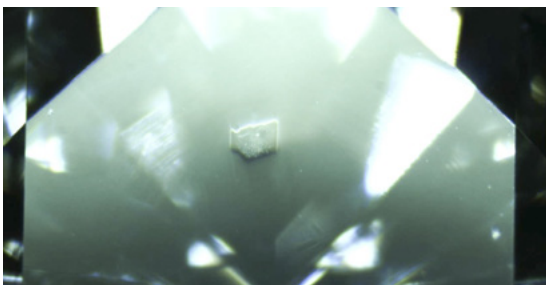

A Knot is an included crystal that reaches the surface of a polished diamond. Knots of diamonds oriented in different directions than the host diamond are often accompanied by polishing lines.

Needle

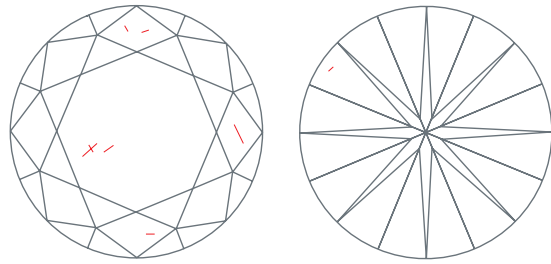
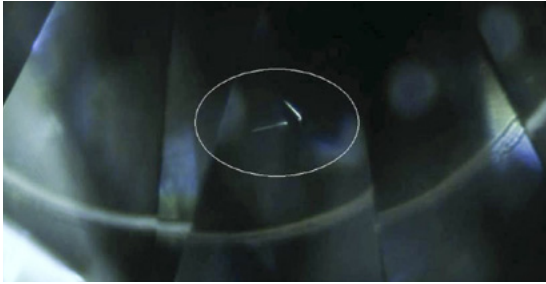

A Needle is a thin, long rod-like crystal. Needles can be grade setters for all clarities from VVS through SI. As with other features when a needle is open or touching a facet, this feature is plotted on that facet.

Pinpoint

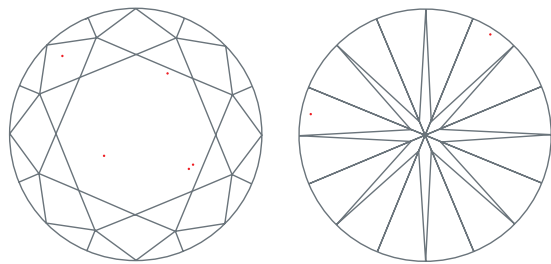

A Pinpoint is a very, very small inclusion seen as a tiny dot that is not identifiable as a crystal at 10X. Pinpoints seen at 10X are grade setters for VVS, may be part of grade setters for VS1 and, rarely, VS2, and is ignored on SI clarity diamonds. Proportionate to the degree of human discernibility using 10x magnification a pinpoint has a minimum diameter of 4 microns and a maximum of about 11 microns before this inclusion is identified as a crystal. Recognizing the range of size of pinpoints, graders plot two sizes of pinpoint.

Twinning Wisp

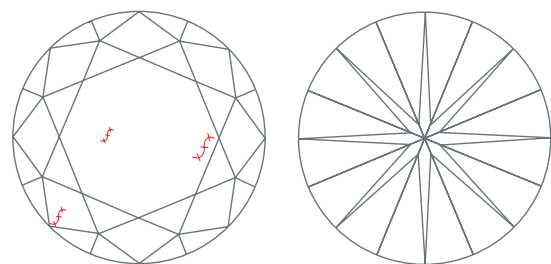
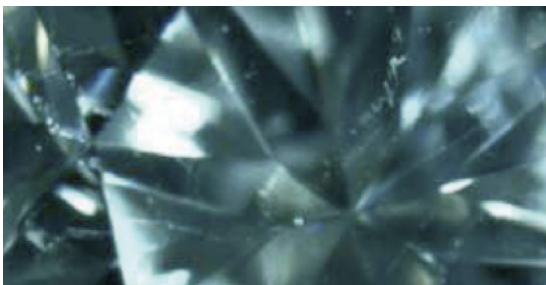

A Twinning Wisp is a thread-like group of inclusions such as crystals, needles, etch channels and pinpoints located on the twin plane of a macule or twin crystal.

2.3.1.3 Plotting features

Clarity features are found in and on a polished diamond that are detected and evaluated while establishing a clarity grade. During grading icons depicting clarity features are plotted on a diagram which appears in the De Beers Group Institute of Diamonds Grading Report.

Clarity features that reach the surface of the pavilion or are visible only through the pavilion are plotted on the pavilion plot. Features that reach the surface of both the crown and the pavilion are plotted on both plots. Feathers and naturals that are found entirely in the girdle are plotted slightly outside the crown plot. All other clarity features are plotted on the crown. Extra facets and naturals may be plotted on both crown and pavilion plots. Only clarity features, naturals and extra facets appear on the grading report.

A totally included clarity feature appearing in two or more facets is plotted in the facet closest to 90 degrees to grader's view. A pinpoint appearing in a star and a bezel facet is plotted in the star, for example. Another way to remember is the feature is plotted in the facet nearest to the centre of the table. Icons for naturals, polish features, and symmetry faults are plotted where appropriate. This information is used in grading Polish and Symmetry and kept in the data base. Polish and symmetry icons do not appear on the grading report.

| RED | RED/GREEN | GREEN | BLACK |
|----------------------------|------------------|-------------------|-------------|
| Beard | Cavity | Abrasion | Extra Facet |
| Bruise | Indented Natural | Burn | |
| Chip | Knot | Laser Mfg Remnant | |
| Cloud | | Natural | |
| Crystal | | Nick | |
| Etch Channel | | Pit | |
| Feather | | Polish Lines | |
| Grain Centre | | Rough Girdle | |
| Internal Graining | | Scratch | |
| Internal Laser Mfg Remnant | | Surface Graining | |
| Needle | | | |
| Pinpoint | | | |
| Twinning Wisp | | | |

Plotting icons

2.3.1.4 Clarity definitions

FL – Flawless

A Flawless diamond has no internal or external features or characteristics visible at 10X with the exception of an inscription or laser brand that has been approved as appearing not to penetrate the surface at 10X.

Flawless refers to the internal and external integrity of the diamond, thus demanding both its polish and symmetry be Excellent. Discrete extra facets not visible face up and naturals appearing exclusively in the girdle that do not influence the diamond's roundness or profile are allowed on a Flawless diamond.

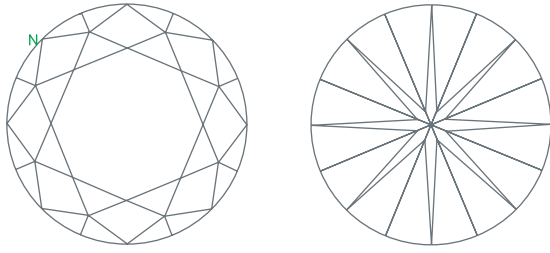

FL plot

IF – Internally Flawless

An Internally Flawless diamond shows no internal features and only insignificant surface features at 10X such as scratch, pit, burn, polishing lines and abrasion. Such surface features are defined as being easily removable in repolishing with a minimum weight loss.

A very small area of surface graining is allowed so long as it is not an extension of internal graining that is visible at 10X. This is not considered as being removable in repolishing.

An IF grading report has the comment *Minor details of Polish present.*

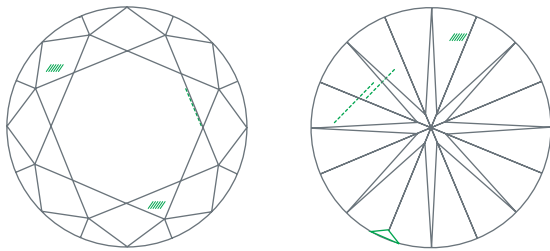

IF plot

VVS1 – Very Very Slightly Included One

A VVS1 diamond exhibits a minute inclusion or two that are extremely difficult to see with a 10X loupe. Some inclusions may only be visible through the pavilion. Inclusion type is generally limited to pinpoint, grain centre, internal graining, or feather. A VVS1 feather is not normally visible from the crown, limited to the girdle or just under the girdle on the pavilion, on the surface, and easily removable with minimum or no weight loss in repolishing. A minute feather or two, extremely difficult to see at 10X, on girdle facets that do not penetrate may sometimes be ignored.

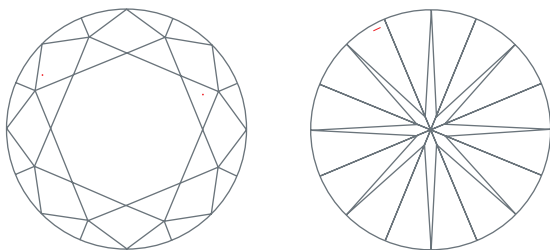

VVS1 plot

VVS2 – Very Very Slightly Included Two

A VVS2 diamond has minute inclusions that are very difficult to see with a 10X loupe. Inclusion types may include pinpoint, feather, grain centre, internal graining, bruise, needle, and cloud. Two pinpoints are plotted as such - three pinpoints together in a group are plotted as a small cloud.

Emphasis is placed on the location and difficulty in finding and seeing a VVS2 inclusion. For example a very small VS1 crown feature may be a VVS2 feature if limited to the girdle or the pavilion just under the girdle and not visible through the crown. A VVS2 clarity feature is difficult to find but once found is difficult to overlook. Beard with penetrating feathers seen face up limits a diamond to a maximum VVS2.

Allowance may also be made for ease in removal of a VVS2 inclusion on the surface in repolishing with minimum or no weight loss, such as a shallow feather or knot.

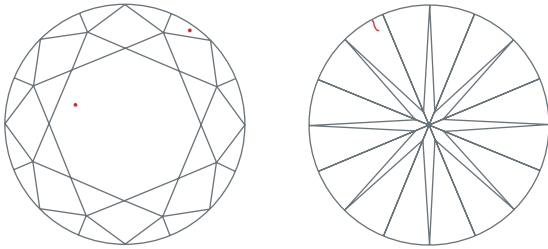

VVS2 plot

VS1 – Very Slightly Included One

VS1 diamonds contain minor inclusions difficult to see with a 10X loupe. Characteristics include internal graining, pinpoint, grain centre, crystal, feather, needle, indented natural, cloud, knot, bruise, and chip.

A VS1 diamond may contain a large dispersed cloud that is loupe visible through the pavilion and not through the crown. When plotting the small crystal, De Beers Group Institute of Diamonds graders are limited to a maximum grade of VS1.

VS1 diamonds are closely related to the VVS clarity group.

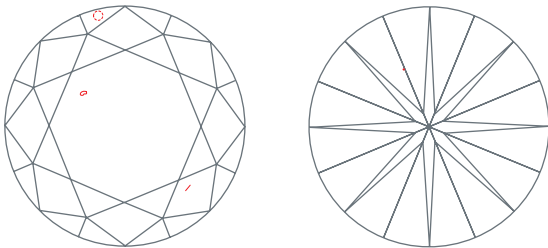

VS1 plot

VS2 – Very Slightly Included Two

A VS2 diamond is one with minor internal characteristics that are somewhat easy to see with a 10X loupe. All natural inclusions are available for a VS2 grade.

VS2 is considered the best clarity grade in which a diamond begins to show inclusions or groups of inclusions somewhat easily face up to the loupe. A VS2 diamond may contain two inclusions that separately could grade a diamond VS2, depending upon location and visibility. A VS2 diamond may have a small black crystal in the table. Or a table inclusion on an SI1 diamond may be a VS2 inclusion if located under a crown facet or in the girdle.

Indented naturals may either set a VS2 grade or have no influence upon a VS2 with another grade setter depending upon number and size. Minute inclusions such as pinpoints or bruises have little influence upon a VS2 grade.

The VS2 – SI1 boundary is the one most difficult to describe yet forms another logical step in grading from Flawless through SI2. A VS2 is more closely related to the SI group than to the VVS group. The differences between VS2 and SI1 are readily seen at 10X. In extremely rare cases, large diamonds, or in significantly transparent fancy shapes like emerald cuts, a VS2 inclusion may be just barely visible to the unaided eye.

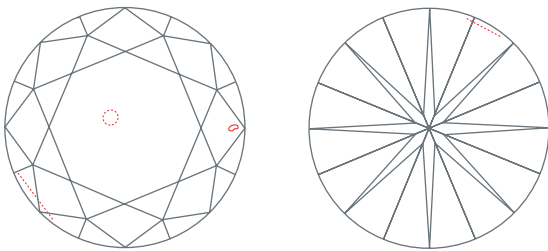

VS2 plot

SI1 – Slightly Included One

An SI1 diamond has noticeable inclusions easy to see at 10X. All natural inclusions can be present in an SI1. Table inclusions become more obvious at 10X but an SI1 is closer to VS than to I-I diamonds whose included characteristics can be visible to the unaided eye or whose transparency is obviously reduced.

An SI1 diamond may be full of dispersed cloud easily visible through the table, but neither the diamond's transparency nor face up appearance may be affected by such cloud. Small indented naturals have no influence upon the grade of an SI1 diamond.

The grade setting features are quickly plotted and assessed on an SI1. Only enough features to set the SI1 grade are plotted, others are ignored.

In some rare cases, large diamonds, or transparent fancy cuts, an SI1 clarity feature may be just visible to the unaided eye.

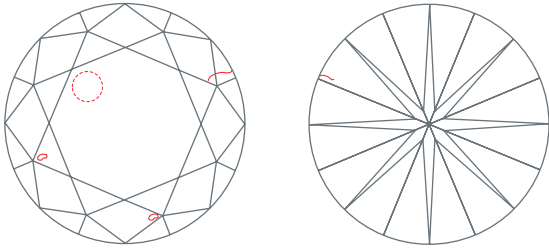

SI1 plot

SI2 – Slightly Included Two

An SI2 diamond has noticeable characteristics that are very easy to see at 10X. An SI2 should have inclusions that are just not visible to the unaided eye in the face up position.

Inclusions may be just visible through the pavilion on a white background such as a colour card. However large, highly contrasting inclusions, such as large black crystals, readily seen in this position are graded I-1.

Diamonds full of cloud, very easily visible at 10X through the table, are still graded SI2 so long as neither their face up appearance nor transparency of the diamond is affected. Diamonds seen as hazy to the unaided eye are graded I-1, I-2 or I-3.

Three or four features are normally enough to clarity grade a diamond. Features necessary to set a grade are plotted or mentioned plus those obvious at 10X and can serve as identifiers. Other minor features are ignored. Pinpoints on an SI2 are not relevant.

In some cases or in transparent fancy cuts an SI2 inclusion may be visible to the unaided eye. Note that in large or exceptionally large diamonds, grade setting characteristics may be proportionately larger and thus possibly more visible to the unaided eye.

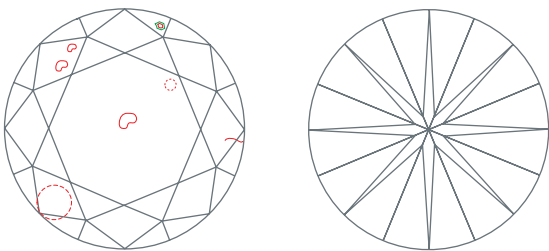

SI2 plot

I-1 – Included One

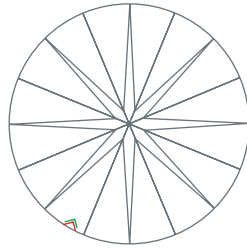
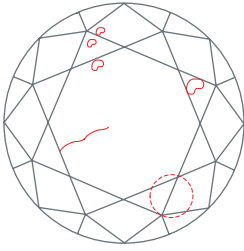

An I-1 diamond contains inclusions or features that are somewhat difficult to find with the unaided eye in the face up position. Contrasting features may be readily seen when the diamond is placed on a white background such as a colour grading card.

I-1 plot

I-2 – Included Two

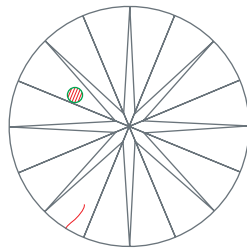
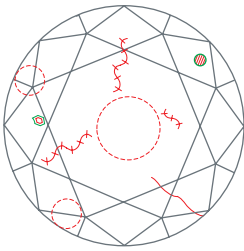

An I-2 diamond contains inclusions that are larger and/or numerous and can easily be found and seen with the unaided eye in the face up position. An I-2 may have its durability affected by knots that can fall out or cleavages. Sections of an I-2 may appear dull or lifeless to the unaided eye.

I-2 plot

I-3 – Included Three

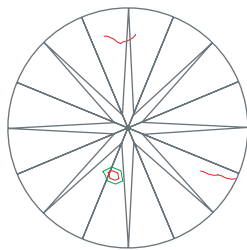
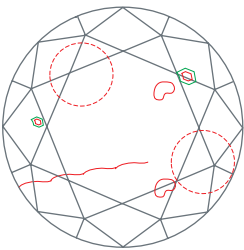

An I-3 diamond contains large and/or numerous inclusions that can very easily be found and seen with the unaided eye. The transparency of the diamond is being seriously compromised by the clarity features. And I-3 may have serious durability issues involving cleavages or open feathers. Very large sections of an I-3 may appear lifeless to the unaided eye.

I-3 plot

2.3.1.5 Grading prompts

Graders note the similarities in the degree of visibility at 10X of features used in grading not only Clarity but also Polish and Symmetry. The visibility of minuscule clarity features found in a VVS diamond would also describe the maximum visibility of features allowable for Excellent polish or symmetry. Minor features found in a VS diamond have the same visibility of allowable features or characteristics for Very Good Polish and Symmetry. And noticeable features easily seen at 10X, like those found in an SI diamond, have the same visibility as features used in grading Good polish or symmetry.

| SIZE | CLARITY | POLISH | SYMMETRY | VISIBILITY AT 10X |
|--------------|----------|-----------|-----------|-----------------------------|
| Minuscule | VVS | Excellent | Excellent | Extremely or Very Difficult |
| Minor | VS | Very Good | Very Good | Difficult to See |
| Noticeable | SI | Good | Good | Easily Seen |
| Obvious | I-1 | Fair | Fair | Very Easily Seen |
| Very Obvious | I-2, I-3 | Poor | Poor | Eye Visible |

Grading prompts

2.3.1.6 Clouds and clarity grading

A Cloud is defined as a hazy area in a diamond consisting of minute inclusions or a closely arranged group of small inclusions such as pinpoints, needles or crystals.

There are three ways of approaching the internal feature cloud in grading. Each way best grades a diamond and also minimizes its impact upon a grading report. Like other features, clouds are plotted or mentioned only when necessary to justify a clarity grade.

Five sizes of cloud icon are used in plotting the size and specific locations of clouds visible with a 10X loupe. Two comments, *Additional clouds not shown* and *Grade based upon cloud* are also used to define clarity on the grading report.

Cloud Plotting Icons

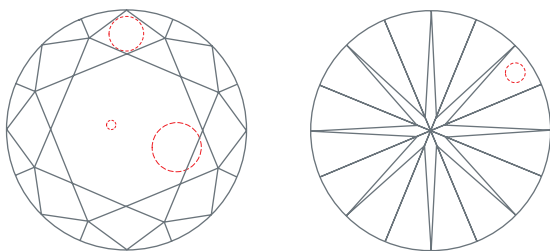

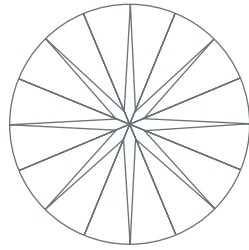
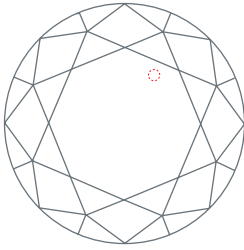

In a VVS1 diamond a cloud that sets this grade is the only clarity feature and is minute and consists of only a few pinpoints. Size and the location being critical in grade setting, the small cloud icon is plotted.

VVS1 Cloud

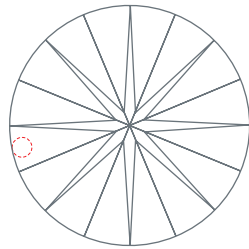
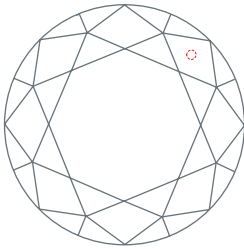

A VVS2 may have a small cloud as its grade setter and this is also plotted. With a larger cloud that is visible only through the pavilion a medium cloud may be plotted for a VVS2.

VVS2 with Cloud as grade setter

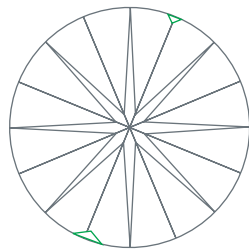
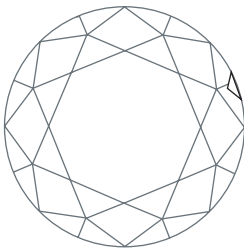

There are no red or red / green features plotted for a diamond whose grade is based upon cloud. Extra facets and naturals however are plotted.

VS1 to I-3 with no plotted clarity icons, Grade based upon cloud

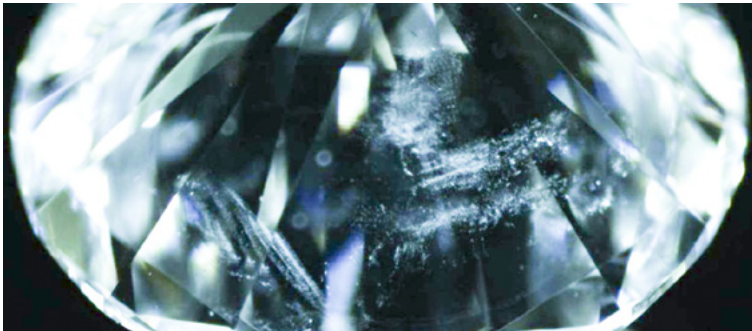

Specific Cloud - to be plotted

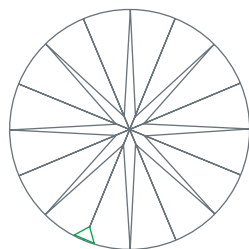
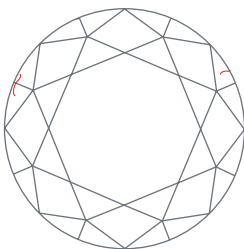

A VS1 diamond may also have specific clouds whose size and location are plotted to determine the VS1 grade. Or its largest feature may be a small feather which may not be enough to justify its grade. When clouds combine with the feather to determine the VS1 then the grader plots the feather and comments *Additional Clouds not shown*.

VS1 Feather and Additional Clouds not shown

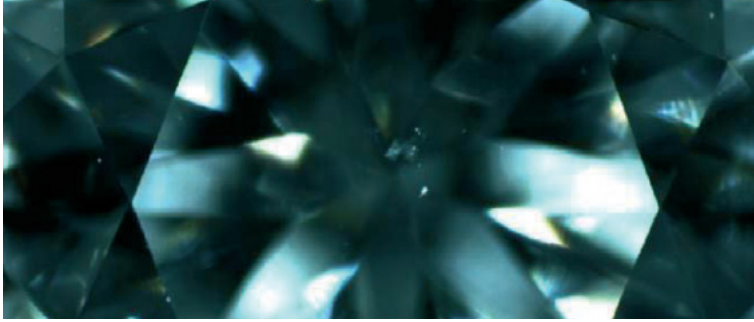

Specific Cloud to be plotted

Diamonds VS2 through I-3 may use combinations of plotted clouds or other features as grade setters.



VS1 *Grade based upon cloud*

A VS1 may have as its grade setter a diffused cloud throughout a large part of the diamond. Here nothing is plotted and the comment *Grade based upon cloud* is used. This type of VS1 cloud is visible through the pavilion yet not through the crown with a 10X loupe.

A VS2 *Grade based upon cloud* contains a diffused cloud readily visible through the pavilion and only just visible through the crown with the loupe.

An SI1 *Grade based upon cloud* has cloud throughout that's readily visible at 10X through the crown yet retains full brilliance and not appear hazy or milky. An example is a diamond with a large snowy cloud of pinpoints, impossible to count, easily seen through the table.

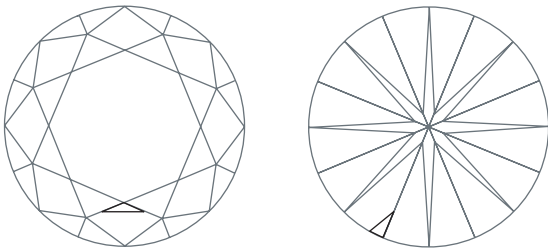

Grade based upon cloud **with extra facets**

An SI2 *Grade based upon cloud* can be hazy with cloud as its brilliance to the loupe becomes reduced. This loss of brilliance is not visible to the unaided eye as would be the case in an I-1. A simple test is to compare its face up appearance with another cloudless diamond.

Although obvious to the 10X loupe an I-1 diamond with dispersed cloud is detectable with the unaided eye only when comparing with another cloudless diamond.

An I-2 cloudy diamond is obvious enough to the unaided eye yet as there is still some life it won't be mistaken for anything but a diamond.

A cloudy I-3 diamond is so dull and lifeless to the unaided eye it can be easily mistaken for something other than diamond.

2.3.1.7 Crystals and clarity grading

The human eye can discern separation between two objects at between 40 and 50 microns. Then the smallest visible objects at 10X magnification would logically be about 4 -5 microns across. For this reason De Beers Group Institute of Diamonds' smallest pinpoint has a diameter of 4 microns measurable on a microscope fitted with a reticule. Inclusions smaller than 4 microns are thus ignored and Flawless and Internally Flawless are possible grades for diamonds with these. An inclusion of 11 microns across located under a diamond's table is not difficult for a skilled diamond grader to see yet this same sized inclusion located in its crown is. With the difference between VVS2 and VS1 verbally described as difficult and somewhat easy to see, De Beers Group Institute of Diamonds has set the limits to a large pinpoint or a small crystal at 11 microns. This size inclusion located under the table is a small crystal yet in the crown, where it's more difficult to locate, is a large pinpoint. The 11 micron limit sharply defines the difference between VVS2 and VS1.

To determine which size crystal is plotted graders count how many of his crystal would fit in a line between the culet and the edge of the table of his diamond in production. Using the small crystal – count 12 - limits a diamond to a maximum grade of VS1. The medium crystal – count 7 - limits a grade to a maximum of VS2. The large crystal – count 5 - limits a grade to maximum SI1 and the extra large crystal – count 3 - means that a diamond cannot be better than SI2. Counting relative size and contrast of other similar features like knots, cavities and feathers can also be applied in this method.

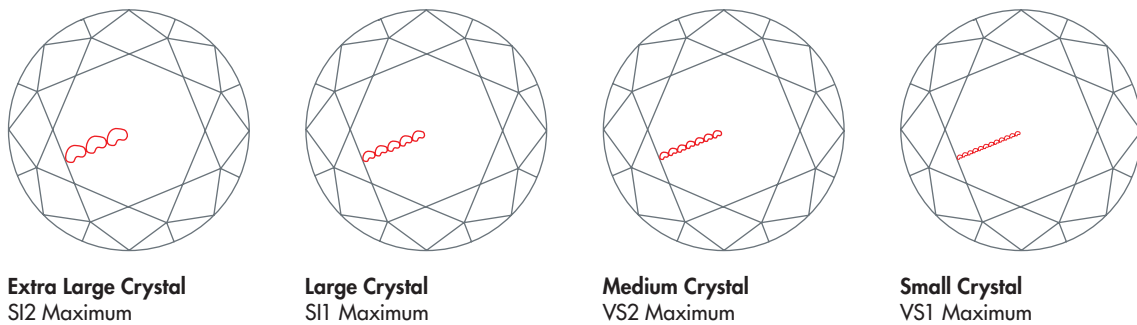

2.3.1.8 Internal graining and clarity grading

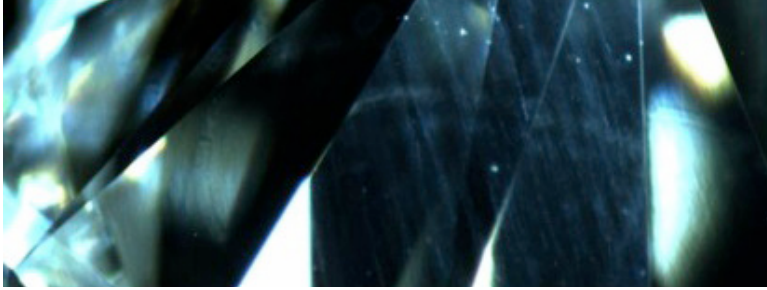

De Beers Group Institute of Diamonds graders divide a polished diamond's structural anomalies into two different sections of grading. Internal Graining is a clarity feature while Surface Graining is a polish feature.

Transparent Internal Graining

Internal Graining neither reflective nor coloured and that does not significantly affect a diamond's transparency is generally ignored in clarity grading. In most cases where Internal Graining is seen as a transparent ripple effect it is neither plotted nor mentioned in a grading report. When this effect is immediately visible viewing the diamond face up at 10X the comment Graining is present may be used.

Internal Graining may also appear hazy or cloudy and have a somewhat negative effect upon a diamond's transparency. A diamond's clarity grade may be reduced by sub-grades, or even full grades depending upon the degree of haziness at 10X. This effect can also generate the comment on the grading report *Grade based upon Internal Graining* when Internal Graining is the clarity grade setter. *Graining is present* is used when Internal Graining is not the only grade setter yet contributes significantly to a diamond's clarity grade.

| CLOUDY INTERNAL GRAINING | | | | | | |
|--------------------------|------------------------------|---|---|---|---|--|
| NONE | ONLY VISIBLE > 10x | VISIBILITY AT 10X | | | | EYE VISIBLE |
| | | DIFFICULT | MINOR | NOTICEABLE | OBVIOUS | |
| IF (3) | IF (4) Internal Comment | VVS 1 Grade Based on Internal Graining | VVS2 Grade Based on Internal Graining | VS1 / VS2 Grade Based on Internal Graining | SI1 / SI2 Grade Based on Internal Graining | I1 / I2 / I3 Grade Based on Internal Graining |
| VVS1 (3) | VVS1 (4) Internal Comment | VVS2 (3) Graining is Present | VS1 (3) Grade Based on Internal Graining | VS2 (3) Grade based on Internal Graining | SI1 / SI2 Grade Based on Internal Graining | I1 / I2 / I3 Grade Based on Internal Graining |
| VVS2 (3) | VVS2 (3) | VVS2 (5) Graining is Present | VS1 (3) Graining is Present | VS2 (3) Grade Based on Internal Graining | SI1 / SI2 Grade Based on Internal Graining | I1 / I2 / I3 Grade Based on Internal Graining |
| VS1 (3) | VS1 (3) | VS1 (4) Internal Comment | VS (3) Graining is Present | VS2 / SI1 Graining is Present | SI1 / SI2 Grade Based on Internal Graining | I1 / I2 / I3 Grade Based on Internal Graining |
| VS2 (3) | VS2 (3) | VS2 (4) Internal Comment | VS2 (5) Graining is Present | SI1 (3) Graining is Present | SI2 Grade Based on Internal Graining | I1 / I2 / I3 Grade Based on Internal Graining |
| SI1 (3) | SI1 (3) | SI1 (3) | SI1 (4) Internal Comment | SI2 (3) Graining is Present | SI2 / I1 Grade Based on Internal Graining | I1 / I2 / I3 Grade Based on Internal Graining |
| SI2 (3) | SI2 (3) | SI2 (3) | SI2 (3) | I1 Graining is Present | I1 / I2 Graining is Present | I1 / I2 / I3 Grade Based on Internal Graining |

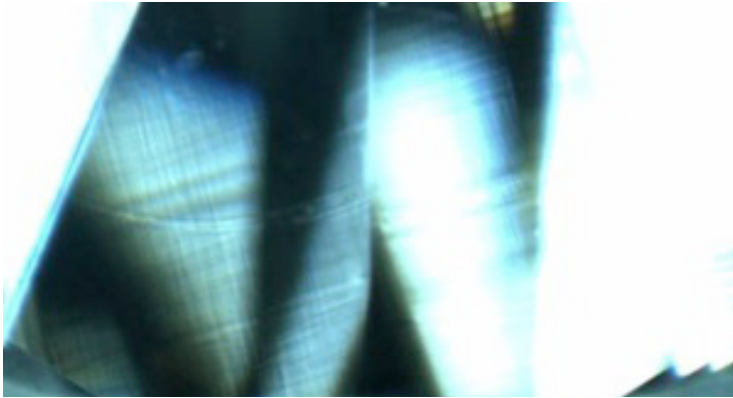

Tatami Mat Internal Graining

Transparent internal graining that takes two directions in crossing itself may have a woven or Tatami Mat effect. Examples severe enough may require the comment *Graining is present*. The comment *Grade based upon graining* is used when internal graining is the grade setter as the only or most obvious clarity feature.

Reflective or mirror-like Internal Graining is graded the same as coloured Internal Graining with special consideration for its visibility. If graining is visible while turning a diamond through only a few degrees of arc, then it is graded as a fraction of another internal feature of equal visibility. A clarity feature, it is plotted or mentioned in the comment section of the grading report and is excluded from Flawless or Internally Flawless.

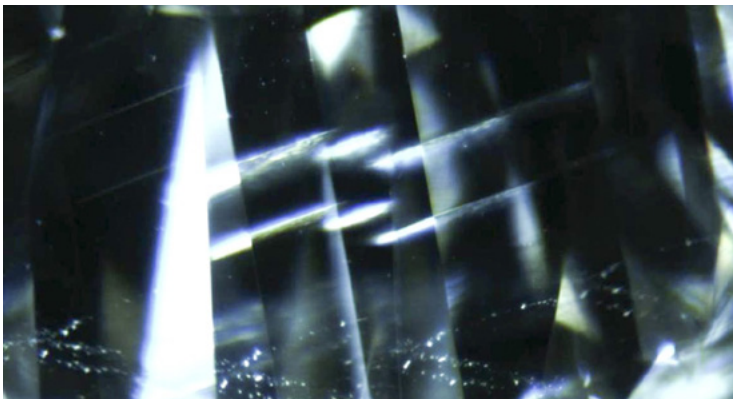

Reflective Internal Graining

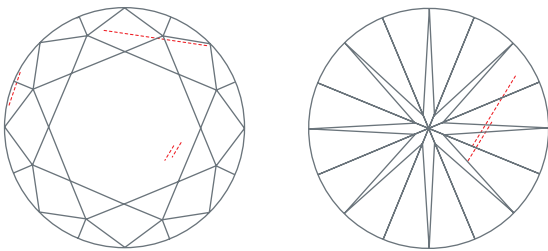

Internal Graining plot

2.3.1.9 Indented naturals and clarity grading

An Indented Natural is a natural that forms a significant depression on a polished diamond and is limited to the girdle or a facet rib. Similar features located elsewhere on a diamond are called cavities. Chips resulting from damage and located on the girdle or a facet rib are not confused with indented naturals. Other holes or depressions located fully on a facet are cavities. All three are clarity features in a polished diamond.

The relative ease in erasing a natural by polishing an extra facet distinguishes a natural from an indented natural. Polishing an extra facet or two to remove a natural takes little time and results in negligible weight loss. Removing an indented natural results in significant weight loss and can affect symmetry so severely as to require repolishing the entire diamond. Removing an indented natural can involve polishing through the girdle for example.

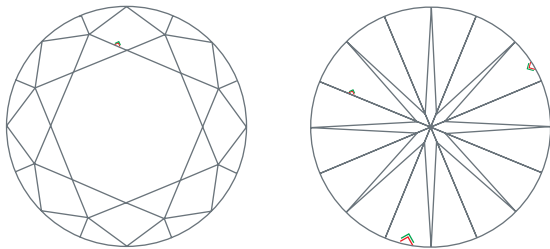

Indented naturals are plotted using a green and red V-shaped icon.

Indented Natural plot

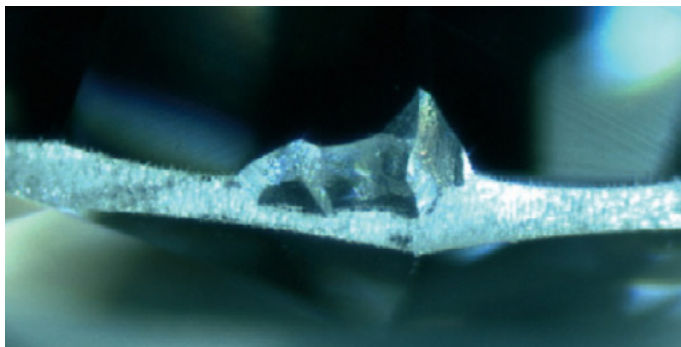

Large indented naturals are plotted adjusting the green natural to its relative size and inserting the indented natural icon. These are considered in both clarity and symmetry grading.

Large Indented Natural – Clarity and Symmetry considerations

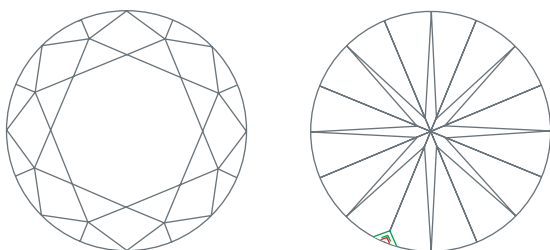

Large Indented Natural plot

Indented naturals are clarity features similar to pinpoints in that they are relevant to VVS and VS clarities yet mostly overlooked on an SI. A VVS1 may have a small indented natural as its only feature yet this would not be plotted on an SI. A large indented natural plotted on an SI2 diamond could be the grade setter for a VS1 with no other features.

As clarities drop from VVS to SI indented naturals become less important. Graders apply the 1–5 sub-grade system to indented naturals according to size and importance to clarity grade.

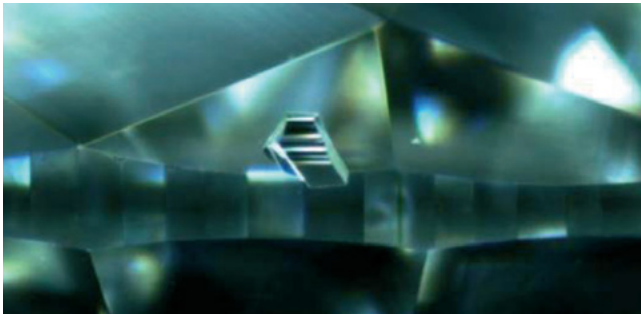
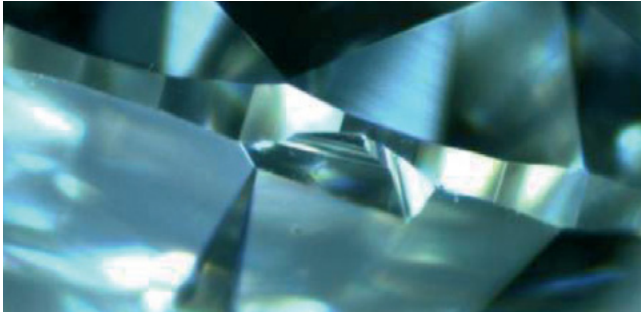

An indented natural with a sub-grade deduction of -5 on a VVS1 may be -3 on a VS1, -1 on a VS2 and not be plotted on an SI diamond. For example a VS1 (4) with a medium indented natural with a relative impact of - 2 sub-grades would change the final clarity grade to VS2 (1). Yet the same indented natural on a VS1 (2) would not change its final grade of VS1 although its sub-grade would drop to (4). The same indented natural would have less influence upon a VS2, say -1 sub-grade. That could still be enough to downgrade a VS2 (5) to an SI1 (1) but would have no influence on either an SI1 or SI2 diamond.

Indented Naturals

2.3.1.10 Rough Girdle, Beard and Clarity Grading

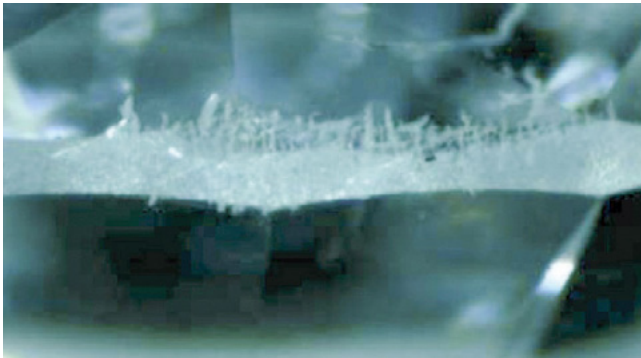

In clarity grading a diamond with a bearded girdle is not better than VVS2. Depending upon the severity of Beard, the clarity grade may indeed be lower. Beard can be considered as rough girdle with accompanying feathers. These feathers comprise the clarity component of beard, while the rough girdle component may lower a polish grade.

Beard

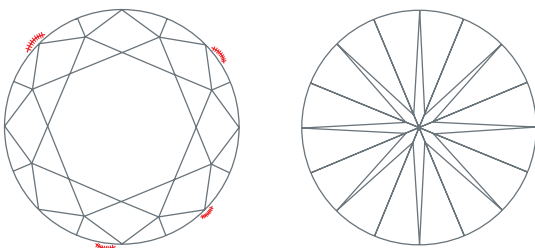

Beard plot

2.4 Cut grade

A diamond's Cut Grade is derived from its Proportions, Polish and Symmetry. Proportions, the most important of these, determine a diamond's light performance.

2.4.1 Proportions

Proportions play the most important role in determining a diamond's light performance. Polish and Symmetry have a somewhat lesser effect. The following chart of minimum and maximum parameters provides an overview of measurements required for a round brilliant. This is a simplification and some combinations of table percentage, crown and pavilion angles may not reach a proportions grade expected from these parameters alone.

| PROPORTIONS: MINIMUM - MAXIMUM | | | | | | |
|--------------------------------|---------|----------------|----------------|----------------|---------------|------------------|
| | | Excellent | Very Good | Good | Fair | Poor |
| Table | | 51.5 – 62.4% | 49.5 – 65.4% | 46.5 – 69.4% | 43.5 – 72.4% | < 43.5 – > 72.4% |
| Total Depth | | 57.5 – 63.0% | 56.0 – 64.5% | 53.0 – 66.5% | 51.0 – 70.9% | < 51.0 – > 70.9% |
| Crown | Angle | 31.3 – 36.2° | 29.3 – 38.2° | 24.3 – 39.2° | 23.3 – 40.2° | < 23.3 – > 40.2° |
| | Height | 12.5 – 17.0% | 10.5 – 18.0% | 9.0 – 19.5% | 7.0 – 21.0% | < 7.0 – > 21.0% |
| Pavilion | Angle | 40.5 – 41.6° | 39.9 – 42.2° | 39.3 – 42.8.0° | 38.9 – 43.2° | < 38.9 – > 43.2° |
| Girdle | Average | 2.3 – 4.5% | 1.8 – 5.5% | 1.5 – 7.5% | 1.5 – 10.5% | < 1.5 – > 10.5% |
| | Minimum | 0.7% | 0.2% | 0.0% | 0.0% | 0.0% |
| | Maximum | 4.8% | 5.9% | 8.2% | 11.2% | > 11.2% |
| Star Length | | 43 – 67% | 38 – 72% | All | All | All |
| Lower Girdle | | 68 – 87% | 63 – 92% | All | All | All |
| Culet Size | | Pointed - 1.5% | Pointed - 3.0% | Pointed - 5.0% | Pointed - 10% | Pointed - > 10% |

De Beers Group Institute of Diamonds Round Brilliant Proportions Min – Max Parameters

A measurement at any one location outside of these limits is enough to lower a diamond's cut grade (see Girdle and Proportions on p35).

Light performance studies have shown that there is a critical interrelationship between table size, crown angle and pavilion angle that determines a diamond's face-up appearance – its beauty.

In the figure below are two examples where table size, crown and pavilion angles combine to produce a proportions grade less than expected from the min – max parameters chart above.

A diamond with a 60% table, 32.5° crown and a 40.7° pavilion has all of these parameters well within min-max parameter ranges for Excellent yet has Very Good proportions due to the effect of their combination on light performance.

Another diamond also with a 60% table, a 31° crown angle and a pavilion angle of 40.5° has these three parameters well within min – max ranges for Very Good proportions yet these combine to produce Good proportions.

Note: More table, crown angle and pavilion angle proportions charts are found in the Appendix.

60 percent table



Crown and Pavilion Angle Combination Chart for a Diamond with a 60% Table

A polished diamond with a cut grade of Excellent requires Excellent proportions but polish or symmetry grades of Very Good do not affect its light performance. Excellent proportions, Very Good polish and Very Good symmetry are thus a valid combination for Excellent cut grade - see table below.

| CUT GRADE | PROPORTIONS | POLISH & SYMMETRY |
|---|--|--|
| EXCELLENT | Excellent | Excellent - Very Good |
| VERY GOOD | Very Good | Excellent - Very Good - Good |
| GOOD | Good | Excellent - Very Good - Good - Fair |
| FAIR | Fair | Excellent - Very Good - Good - Fair |
| POOR | Excellent - Very Good Good - Fair - Poor* | Excellent - Very Good - Good - Fair Poor* |
| *Poor Proportions, Polish or Symmetry limit a diamond's overall Cut Grade to Poor | | |

De Beers Group Institute of Diamonds Round Brilliant Cut Grade combinations

For the same reason a diamond with Very Good proportions requires minimum polish and symmetry grades of Good for an overall cut grade of Very Good. Polish and symmetry grades of Fair limit a diamond to a maximum cut grade of Good. Any single proportions, polish or symmetry grade of Poor limits a diamond's overall Cut Grade to Poor.

2.4.1.1 Girdle and proportions

Like other measurable parameters girdle thickness can limit a diamond's cut grade eligibility. A diamond with an extremely thin or knife-edged girdle is susceptible to chipping or breaking and is therefore limited to Good overall cut grade due to diminished durability. Girdles on excellent proportioned round brilliants are limited to those of minimum 0.7%, average up to 4.5% and maximum of 4.8% at any one place. On Very Good proportioned rounds girdle thickness may average up to 5.5% and measure maximum 5.9% at any one place. The ranges of girdle maximums allow for minor to moderate painting in brilliandeering.

| Average Girdle Thickness | EXCELLENT | VERY GOOD | GOOD | FAIR | POOR |
|--------------------------|-----------|-----------|------|------|------|
| 2.3–4.5% | | | | | |
| 1.8–5.5% | | | | | |
| 1.7–7.5% | | | | | |
| 1.7–10.5% | | | | | |
| 1.7– >10.5% | | | | | |

Average Girdle and Proportions

| Min–Max Girdle Thickness | EXCELLENT | VERY GOOD | GOOD | FAIR | POOR |
|--------------------------|-----------|-----------|------|------|------|
| 0.7–4.8% | | | | | |
| 0.2–5.9% | | | | | |
| 0–8.2% | | | | | |
| 0–11.2% | | | | | |
| 0– >11.2% | | | | | |

Girdle Min-Max and Proportions

Average Girdle Thickness

Extremely Thin 0–1.8%

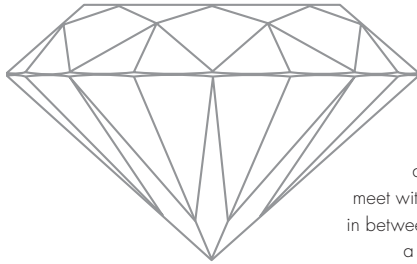

Crown and Pavilion meet with no Girdle in between, creating a knife edge.

Very Thin 0.2–2.1%

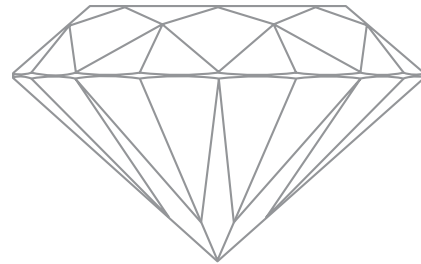

Thin 0.7–2.6%

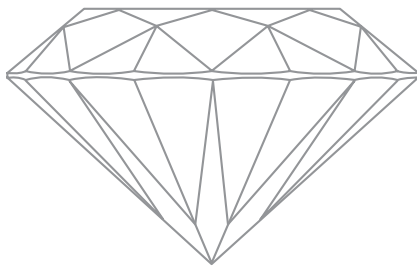

Medium 1.7–3.6%

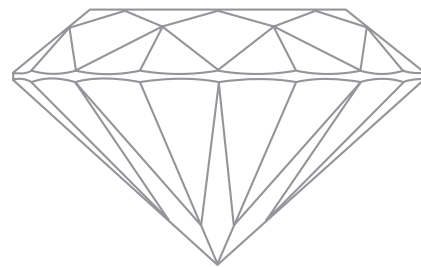

Slightly Thick 2.7– 4.8%

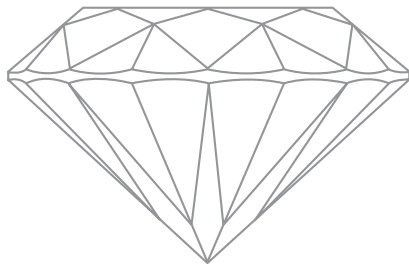

Thick 3.7–5.9%

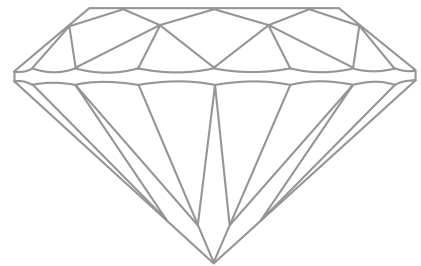

Very Thick 5.7–8.0%

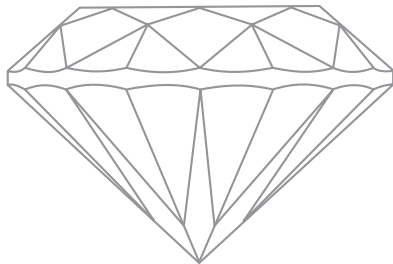

Extremely Thick 8.7–11.0%

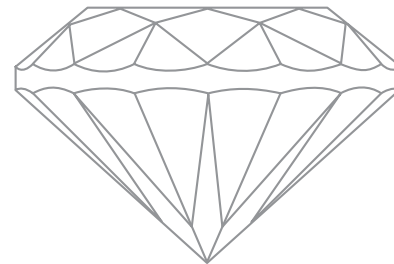

2.4.1.2 Culet and proportions

De Beers Group Institute of Diamonds defines a culet as that part of a polished diamond where its pavilion facets meet. On a well-made, undamaged diamond the culet is Pointed, Natural or Faceted. A natural culet is one where a diamond's pavilion facets meet at a natural or small area of the original rough surface. A polisher may also polish a very small facet on the culet to prevent its abrasion or chipping while in contact with other diamonds. Culets are considered in proportions when natural or faceted and in polish when pointed.

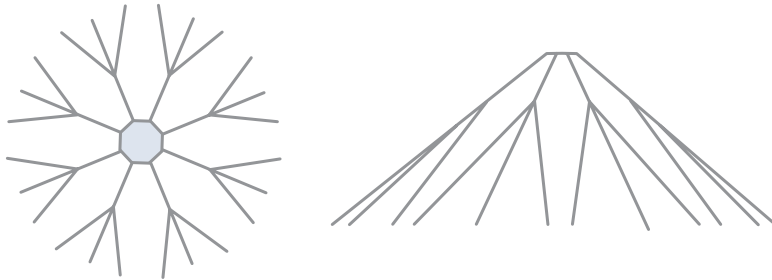

Natural and faceted culet

| Maximum Culet Size | EXCELLENT | VERY GOOD | GOOD | FAIR | POOR |
|--------------------|-----------|-----------|------|------|------|
| Small 1.5% | | | | | |
| Medium 3% | | | | | |
| Large 5% | | | | | |
| Ex Large 10% | | | | | |
| Ex Large > 10% | | | | | |

Culet and Proportions

A diamond with Excellent proportions may have a faceted culet so long as it is very small to small (difficult to see at 10X). A diamond of Very Good proportions may have a medium faceted or natural culet that is somewhat easy to see at 10X. A diamond with a large culet, easily seen at 10X, has Good proportions.

2.4.1.3 Fancy shapes

In addition to Round Brilliants, De Beers Group Institute of Diamonds also grades Fancy Shapes.

Fancy shape diamonds are fashioned from rough that is far less uniform than rough producing round brilliants. These more often follow the shape of the rough than standard diamond designs and therefore present a challenge to developing a standard cut grade using all of the elements used for rounds. For a given fancy shape there may be a dozen different facet arrangements. Most importantly, beauty is in the eyes of the beholder – especially so with fancy shape diamonds. However, there are limitations and market preferences.

De Beers Group Institute of Diamonds grades only polish and symmetry on fancy shapes but can recommend proportions ranges for nine standard fancies. These shapes are:

| | | |
|---------|----------|----------|
| Asscher | Heart | Pear |
| Cushion | Marquise | Princess |
| Emerald | Oval | Radiant |

Asscher Cut

An Asscher Cut like the square emerald cut is a square, cut cornered step cut diamond. The Asscher is distinguished by its pointed culet. Asscher cuts are designed to be square. Those with length to width ratios up to 1.06:1 are still considered to be square.

| ASSCHER CUT | | |
|----------------|-----------|-------------|
| Proportions | Minimum | Maximum |
| LENGTH : WIDTH | 1.00:1 | 1.06:1 |
| Table % | 53% | 67% |
| Crown Height % | 10% | 18% |
| Total Depth % | 58% | 73% |
| Girdle | 0.3% | 7.5% |
| Verbal | Very Thin | Very Thick |
| Culet | Pointed | SI Large 5% |

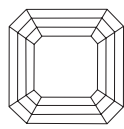
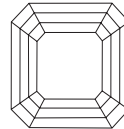
| ASSCHER CUT Length:Width | |
|--|---|
|  |  |
| 1.00:1 | 1.06:1 |

Cushion

| CUSHION | | | |
|----------------|---------|----------------|------------|
| Proportions | Minimum | Maximum | |
| LENGTH : WIDTH | 1.07:1 | 1.30:1 | |
| SQUARE | 1.00:1 | 1.06:1 | |
| Table % | 52% | 68% | |
| Crown Height % | 10% | 18.5% | |
| Total Depth % | 58% | 78% | |
| Girdle | 0.3% | 7.5% | |
| | Verbal | Very Thin | Very Thick |
| Culet | Pointed | Very Large 10% | |

The modern Cushion Cut has recently given a new life to this style of cutting fashionable in the 1800s. A Cushion is a rounded corner square or rectangular shaped diamond whose pillow shape gives it name. Old style - retro Cushions generally have larger facets and may have very large culets.

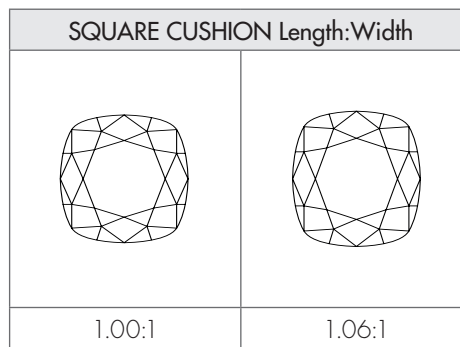
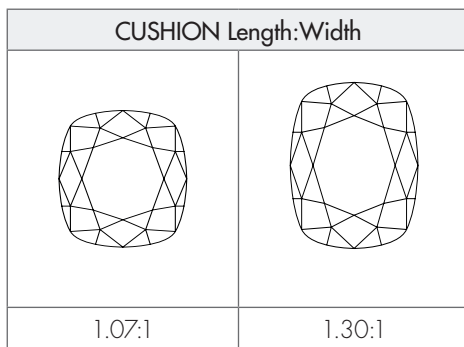

Emerald Cut

| EMERALD CUT | | | |
|----------------|---------|------------|------------|
| Proportions | Minimum | Maximum | |
| LENGTH : WIDTH | 1.07:1 | 1.90:1 | |
| SQUARE | 1.00:1 | 1.06:1 | |
| Table % | 57% | 69% | |
| Crown Height % | 10% | 17% | |
| Total Depth % | 57% | 73% | |
| Girdle | 0.3% | 7.5% | |
| | Verbal | Very Thin | Very Thick |
| Culet | Linear | Faceted 5% | |

An Emerald Cut is described as a cut cornered square or rectangular shape with a step cut facet arrangement. To distinguish it from the Asscher Cut, the Square Emerald Cut has a linear culet.

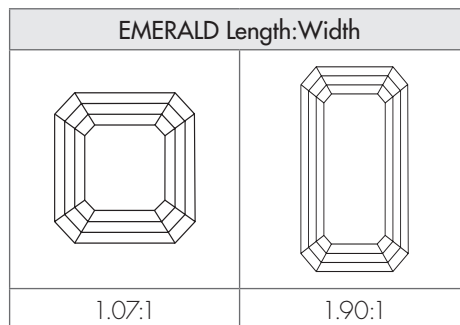
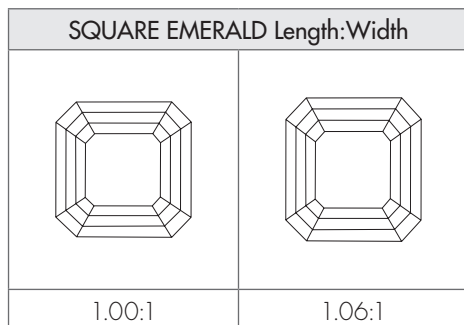

Heart Shape

The Heart Shape brilliant is an otherwise shortened pear shape with a cleft.

A standard heart shape has 58 facets with a ninth bezel located next to the cleft. Variations may have 7 bezels and 4, 6 or 7 pavilion facets. Long heart shapes are generally not acceptable and those with broad shoulders are rare.

| HEART SHAPE | | |
|----------------|-----------|-------------|
| Proportions | Minimum | Maximum |
| LENGTH : WIDTH | 0.77:1 | 1.1:1 |
| Table % | 53% | 66% |
| Crown Height % | 9% | 17% |
| Total Depth % | 50% | 68% |
| Girdle | 0.3% | 7.5% |
| Verbal | Very Thin | Very Thick |
| Culet | Pointed | SI Large 5% |
| SYMMETRY | Good | Excellent |

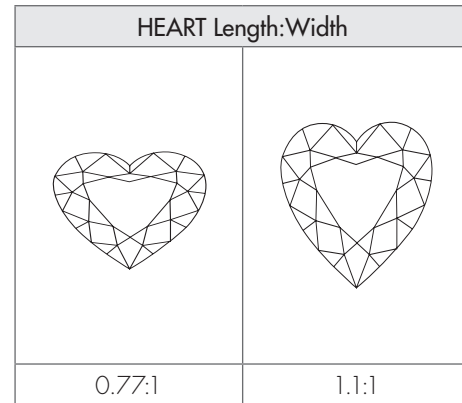

Marquise

The Marquise is a boat shaped modified brilliant that can have the same number of facets as the 57 facet round brilliant. Variations of the Marquise may have 6 or 8 bezel facets and 4, 6 or 8 pavilion facets.

| MARQUISE | | |
|----------------|-----------|-------------|
| Proportions | Minimum | Maximum |
| LENGTH : WIDTH | 1.50:1 | 2.50:1 |
| Table % | 50% | 66% |
| Crown Height % | 10% | 17% |
| Total Depth % | 56% | 68% |
| Girdle % | 0.3% | 7.5% |
| Verbal | Very Thin | Very Thick |
| Culet | Pointed | SI Large 5% |

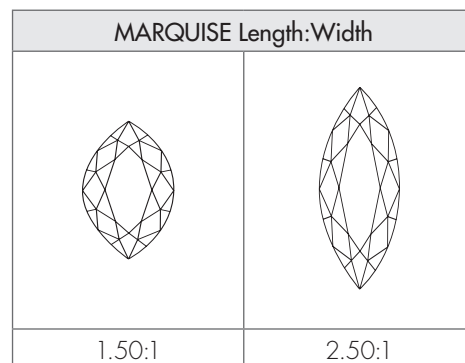

Oval

An Oval shaped diamond has the same facet configuration as an elongated round brilliant with 57 facets. Oval variations are those with 6 bezels and those with 4 or 6 pavilion facets.

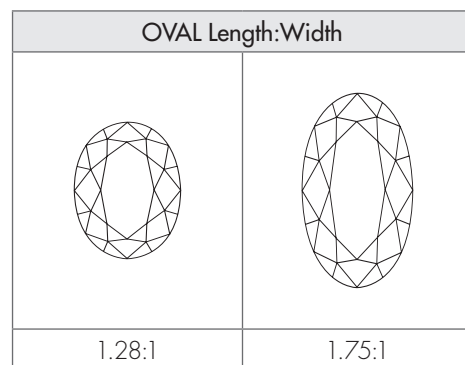

| OVAL | | |
|----------------|-----------|-------------|
| Proportions | Minimum | Maximum |
| LENGTH : WIDTH | 1.28:1 | 1.75:1 |
| Table % | 52% | 66% |
| Crown Height % | 10% | 17% |
| Total Depth % | 56% | 68% |
| Girdle | 0.3% | 7.5% |
| Verbal | Very Thin | Very Thick |
| Culet | Pointed | SI Large 5% |



Pear Shape

The Pear Shape is a combination of a marquise with a round brilliant. Like a round, the pear shape can have 57 facets. Variations include pear shapes with 7 bezels and those with 4, 6 and 7 pavilion facets.

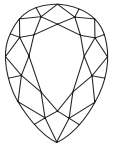
| PEAR | | | |
|----------------|---------|-------------|------------|
| Proportions | Minimum | Maximum | |
| LENGTH : WIDTH | 1.35:1 | 1.90:1 | |
| Table % | 50% | 66% | |
| Crown Height % | 10% | 17% | |
| Total Depth % | 56% | 68% | |
| Girdle | 0.3% | 7.5% | |
| | Verbal | Very Thin | Very Thick |
| Culet | Pointed | SI Large 5% | |

| PEAR Length:Width | |
|--|---|
|  |  |
| 1.35:1 | 1.90:1 |

Princess Cut

Popularized in the 1970s, the Princess Cut offers a maximum weight return from octahedral diamond rough. With its unique pavilion brilliant style a princess cut combines light return, fire and scintillation surpassed only by the round brilliant. The crown has 17 or 21 facets and the pavilions with 2, 3 and 4 chevrons have 24, 32 or 40 facets respectively plus 4 girdle facets. Princess Cuts are designed to be square.

| PRINCESS | | | |
|----------------|---------|-------------|------------|
| Proportions | Minimum | Maximum | |
| LENGTH : WIDTH | 1.00:1 | 1.06:1 | |
| Table % | 57% | 79% | |
| Crown Height % | 7% | 17% | |
| Total Depth % | 62% | 81% | |
| Girdle | 0.3% | 7.5% | |
| | Verbal | Very Thin | Very Thick |
| Culet | Pointed | SI Large 5% | |

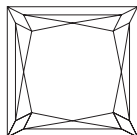
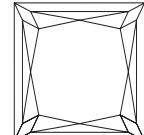
| PRINCESS Length:Width | |
|--|---|
|  |  |
| 1.00:1 | 1.06:1 |

Radiant

A Radiant is a cut cornered square or rectangular shape with crown facet arrangement similar to princess cut and what can be described as an emerald cut with a pointed culet and brillianteering facets on the pavilion. Actual facet arrangement on a radiant varies widely in retaining weight from the rough. Many Radiants are cut with deep pavilions especially those with fancy colours.

| RADIANT | | | |
|----------------|---------|-------------|------------|
| Proportions | Minimum | Maximum | |
| LENGTH : WIDTH | 1.07:1 | 1.70:1 | |
| SQUARE | 1.00:1 | 1.06:1 | |
| Table % | 55% | 70% | |
| Crown Height % | 10% | 18% | |
| Total Depth % | 58% | 80% | |
| Girdle | 0.3% | 7.5% | |
| | Verbal | Very Thin | Very Thick |
| Culet | Pointed | SI Large 5% | |

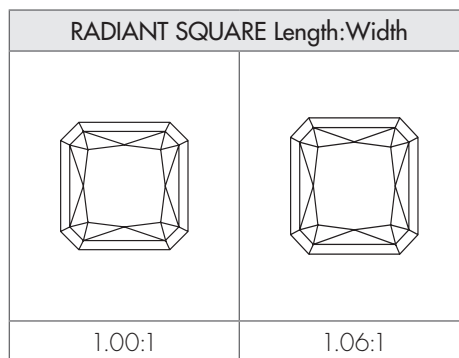
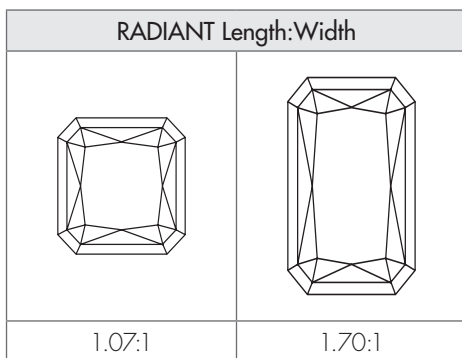

2.4.2 Finish grading

While Sarin measures parameters that determine a diamond's Proportions, graders assess Finish, comprised of Polish and Symmetry grades.

Polish is interpreted as the condition of the diamond after polishing plus any additional features such as nicks, abrasions, scratches and chips that may have occurred since. Plotting icons for these and the other polish features of burn, polishing lines, rough girdle, pit, and surface graining, graders determine the polish element of a diamond's finish.

Graders also use a simple blue icon for plotting location symmetry faults. Symmetry on a round brilliant, for example, refers only to the regular and uniform arrangement of its 57 normal facets. De Beers Group Institute of Diamonds considers extra facets and naturals (not indented) equally and exclusively as symmetry features.

A grader refers to his detailed check list including twist, girdle variation, pointing, misshapen facets, roundness, extra facets, pavilion angles, crown angles, and lower girdle facet check - plots his icons and then grades a diamond's symmetry based upon number and location of faults, as well as their visibility at 10X.

Finish grading sets the maximum overall cut grade of a diamond. A Good grade for either symmetry or polish limits a diamond to a maximum cut grade of Very Good, even if its proportions are Excellent. A cut grade of Excellent requires both polish and symmetry to be minimum Very Good. Any finish grade of Fair limits cut grade to maximum Good. However any grade of Poor will limit a diamond's cut grade to Poor.

Both polish and symmetry are graded with sub-grades 1 through 5 in the same way as clarity.

2.4.2.1 Polish grading

De Beers Group Institute of Diamonds polish grades of Excellent, Very Good, Good, Fair and Poor receive cues from the degree of visibility as well types of features found on a polished diamond. The conditions of a diamond’s culet and girdle are also considered in polish grading.

A diamond with Excellent polish may have a minute scratch, a few pits, a pavilion burn or some light polishing lines that are extremely to very difficult to see with a 10X loupe. This diamond is limited to a pointed, faceted or natural culet and may have only small segments of rough girdle.

A Very Good Polish diamond has minor features that are somewhat easily seen at 10X. These include Pits, Nicks, Scratches, Abrasions, Polishing Lines, Surface Graining, very small Bump Facets, and small areas of Burn. This diamond may have large segments of Rough Girdle, Laser Manufacturing Remnants and may have an abraded Culet.

A diamond with Good polish has features noticeable at 10X yet not visible to the unaided eye. In addition to features allowed on Very Good, Good can have white polishing lines, heavy burn, and unpolished sections of laser rough division. A Good polish diamond may have significant laser manufacturing remnants and an overall rough girdle as well as a chipped culet.

Diamonds with Fair polish exhibit heavy, cloudy or lizard skin burn, sections of heavy girdle beard, significant areas of white polishing lines, large laser manufacturing remnants or other features that are obvious at 10X. Broken culets have both a Clarity and a Polish component in grading. This diamond’s clarity is determined by the size of the break and is plotted with the Chip icon. It’s polish is determined by the relative amount of weight loss in repair of the culet. A slightly broken culet is graded less harshly than one which requires a full re-cut of the diamond.

| | POLISH GRADE | | | | |
|----------------|--|--|---|---|---|
| | Excellent | Very Good | Good | Fair | Poor |
| Size | Minute | Minor | Noticeable | Obvious | Very Obvious |
| 10X Visibility | Difficult | Somewhat Easy | Easily Seen | Readily Seen | Eye Visible |
| Features | Nick, Pit Scratch Abrasion Polishing Lines Surface Graining Very Light Burn | Nick, Pit Scratches Abrasions Polishing Lines Surface Graining Burn Rough Girdle Segments Laser Girdle Marking Remnants | Nick, Pit, Scratches Abrasions White Polishing Lines Surface Graining Heavy Burn Overall Rough Girdle Laser Manufacturing Remnants | Nick, Pit Scratches Abrasions Heavy White Polishing Lines Surface Graining Cloudy or Lizard Skin Burn Beard and Rough Girdle Laser Manufacturing Remnants | Nick, Pit Scratches Abrasions Heavy White Polishing Lines Surface Graining Heavy Cloudy or Lizard Skin Burn Heavy Beard and Rough Girdle Laser Manufacturing Remnants |
| Culet | Pointed Natural Faceted | & Abraded | & Chipped | & Broken | & Broken |

Polish grade features

2.4.2.2 Polish features

Abrasion

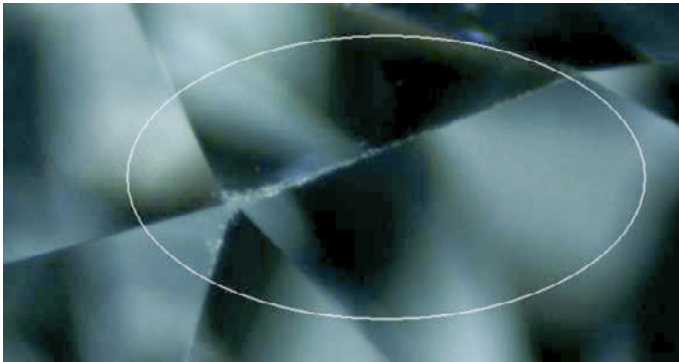

Sub-microscopic chips or nicks on a facet rib producing a fuzzy effect instead of a sharp facet edge define Abrasion. This may result from careless polishing or contact with other diamonds.

Burn



Surface clouding or rippling caused by excessive heat in polishing or polishing against a diamond's polishing direction. Cloudy burns that diminish a diamond's brilliance may also affect its clarity grade.

Laser Girdle Marking Remnants

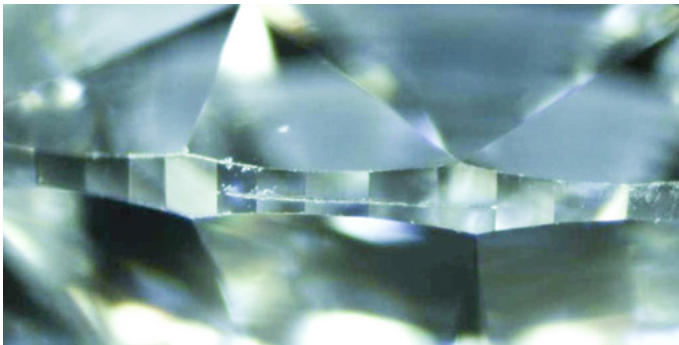

Lasering in or near the girdle indicates the extent of faceting for the brilliandeerer and is ordinarily removed during polishing. Deeper girdle marking lasering or a remnant left fully on a facet off the girdle may be clarity graded as an open feather.

Laser Rough Division Remnants

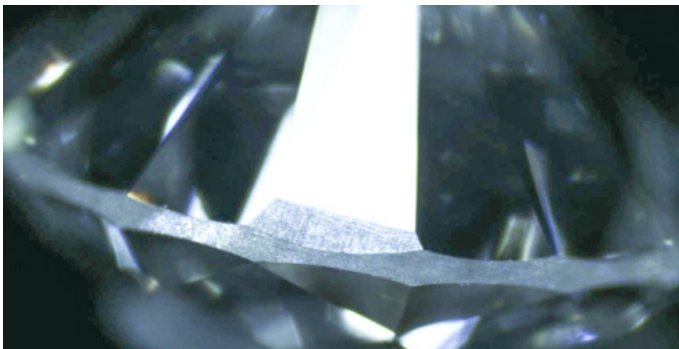

These are laser sawing burns from dividing a rough crystal and left unpolished in manufacture.

This feature is plotted using a burned extra facet with implications in both polish and symmetry.

Nick ✕

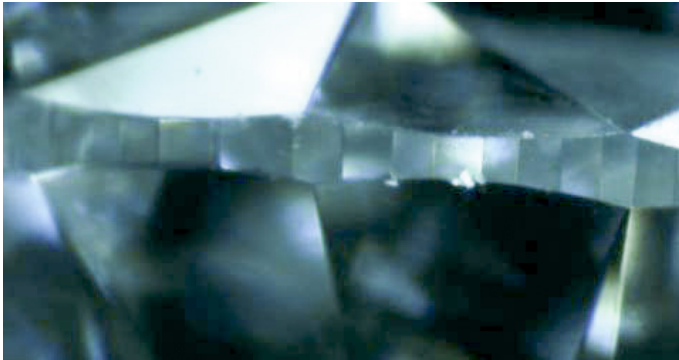

A Nick is damage in the form of a small notch on a facet edge or on the girdle.

Pit •



A Pit is a pinpoint sized hole located fully on a facet and not on a facet rib or edge of the girdle (when they would be called nicks).

Polishing Lines ///// ////

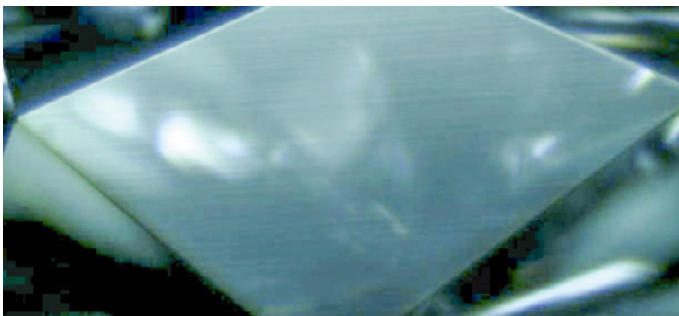

Polishing lines are fine parallel lines left after polishing with a separate and distinct direction on each facet. These can result from poor finishing or from a knot or a cloud of knots reaching the surface of that facet.

Rough Girdle 🌿

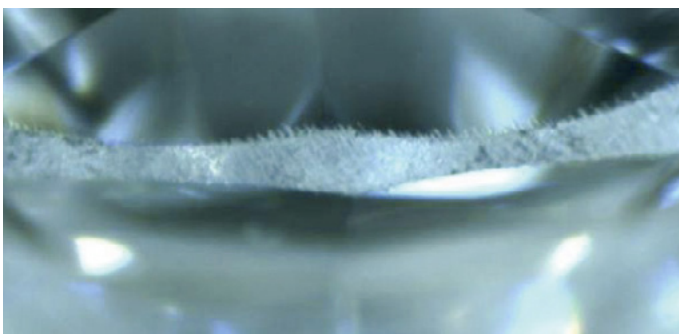

Grainy or pitted girdle sometimes accompanied by nicks and beard or small girdle feathers. When rough girdle's feathers appear to penetrate a diamond viewed face up it becomes a clarity feature. Such diamonds are not graded better than VVS2.

Scratch

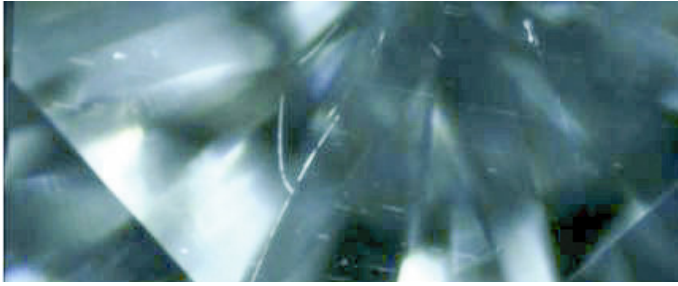

With its extreme hardness only another diamond can scratch a diamond. A Scratch is a linear feature that usually does not extend from a facet to the adjacent one as can a feather. These can form both in manufacture and in everyday wear and tear. Scratches formed while polishing can also be

distinguished from feathers when oriented in the same direction as polishing lines on the same facet. Circular scratches on the table can occur when diamond grit from the polisher's wheel gets into the stone holder or dop.

Surface Graining



External or surface indication of a diamond's internal structural irregularities – localised slight changes in polishing direction. Surface Graining appears to orient itself in slightly different directions as it crosses from one facet to another.

Girdle and polish grading

As a polished diamond's cut grade is also limited by its minimum finish grade the appearance and condition of its girdle are considered in both polish and symmetry. In the case of Beard the girdle may influence or even determine a diamond's clarity grade.

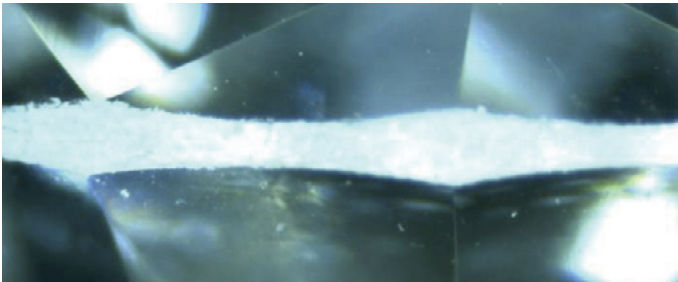

The girdle types are recorded in the database as bruted, faceted, partially faceted or polished.

Bruted Girdle

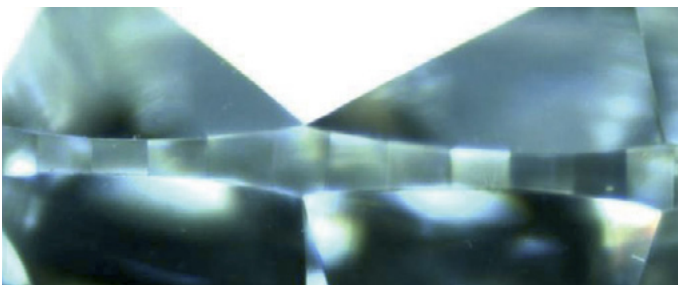

Faceted Girdle

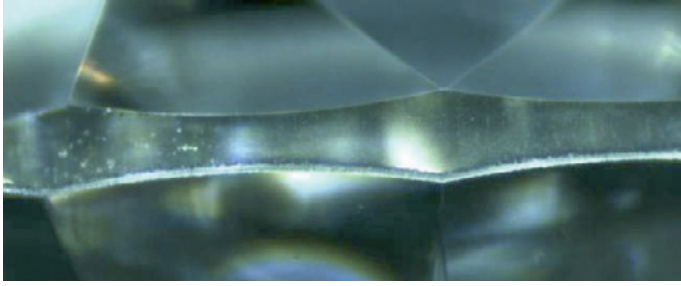

Polished Girdle

Rough girdles

Only a very small area of rough girdle is considered for polish grade of Excellent. A diamond with an overall rough girdle is not considered for Very Good polish but rather Good.

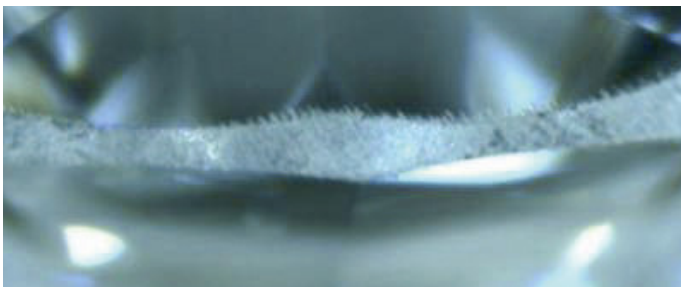

A rough bruted girdle is grainy, pitted, and may have resulted from heavy-handedness in bruting.

Rough Bruted Girdle

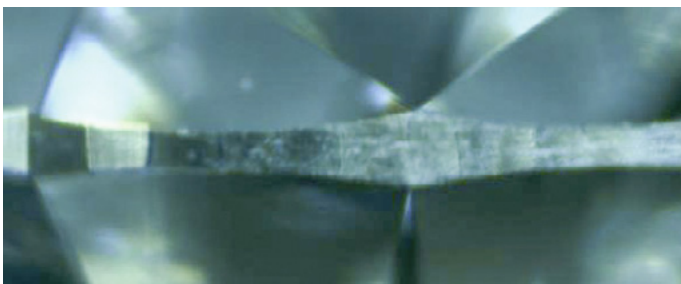

A rough faceted girdle results from incomplete removal of bruting during faceting or burning of girdle facets from polishing against the diamond's polishing grain.

Rough Faceted Girdle

A rough polished girdle (small vertical feathers) may result from excessive pressure upon the diamond during polishing.

Laser girdle marking

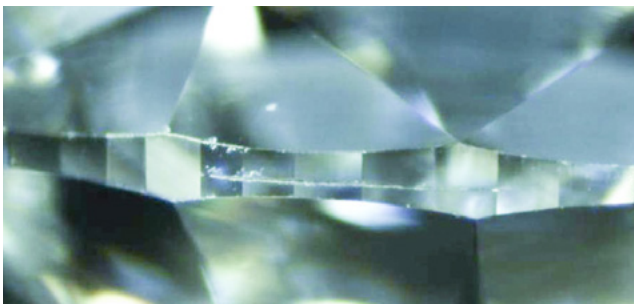

Diamonds with significant remnants of laser girdle marking are also considered in polish grading and are excluded from Excellent.

Remnant of Laser Girdle Marking

2.4.2.3 Culet and polish grading

De Beers Group Institute of Diamonds defines a Culet as that part of a polished diamond where its eight pavilion facets meet. On a well-made, undamaged diamond the culet is Pointed, Natural or Faceted. A natural culet is one where a diamond's pavilion facets meet at a natural or small area of the original rough surface. A polisher may also polish a very small facet on the culet to prevent its abrasion or chipping while in contact with other diamonds. Culets are considered in proportions when natural or faceted and in polish when pointed.

The condition of pointed culets is considered polish grading. An Excellent polish diamond has a pointed culet and may not have an abraded or a chipped culet. A Very Good polish diamond may have an abraded culet but not have a chipped culet. A Good polish diamond may have an abraded or chipped culet but may not have a broken culet. A broken culet limits a diamond's polish grade to Fair or Poor.

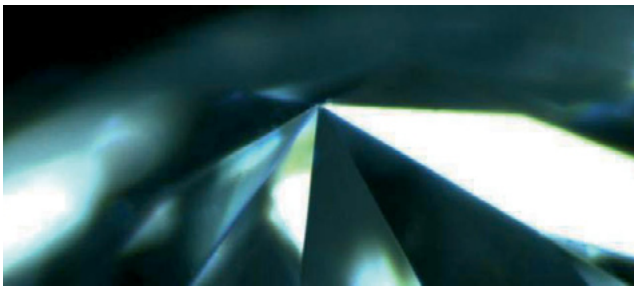

Pointed Culet

A Pointed Culet is one where a diamond's pavilions meet in a sharp, distinct point as seen at 10X. An Excellent polish diamond can have only a pointed, faceted or natural culet – the latter two are considered in proportions.

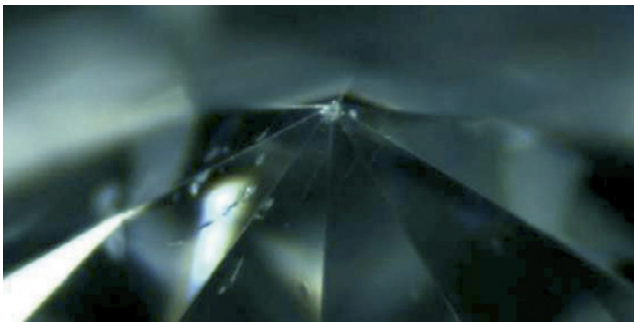

Abraded Culet

An Abraded Culet has had its point worn off either by contact with other diamonds or by impact damage in handling. Difficult to somewhat easy to see at 10X, a diamond with an abraded culet may have Very Good polish. An abraded culet is evenly worn with no discernable chips broken from any single pavilion facet.

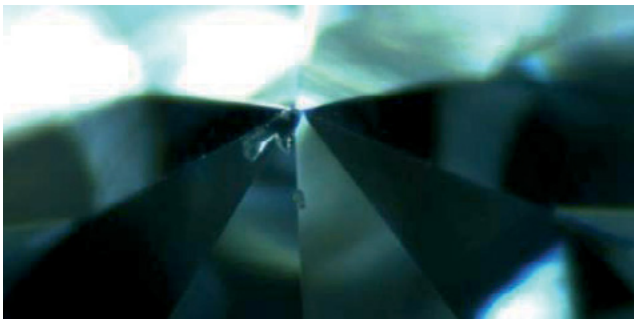

Chipped Culet

A Chipped Culet's point has been broken away and a small chip or two remains in its place. A pavilion facet or two has a distinct piece missing. Noticeable or easily seen at 10X a diamond with a chipped culet may have maximum Good polish. A chipped culet is somewhat easily repairable by repolishing.



A Broken Culet has its point missing and pavilion facets have large pieces chipped away as a result of serious damage in handling. A broken culet is much more difficult to repair. Repolishing will incur significant weight loss, and likely result in downgrades of both proportions and symmetry. A broken culet limits a diamond's polish grade to Fair or Poor.

Broken Culet

2.4.2.4 Surface graining and polish grading

Polished diamonds' structural anomalies are divided into two different sections of grading. Internal Graining is a clarity feature and Surface Graining is a polish feature.

Surface Graining is graded in polish as an external feature such as burn or polishing lines. Small amounts of surface graining that is very difficult to see at 10X may be found on a diamond with Excellent polish.

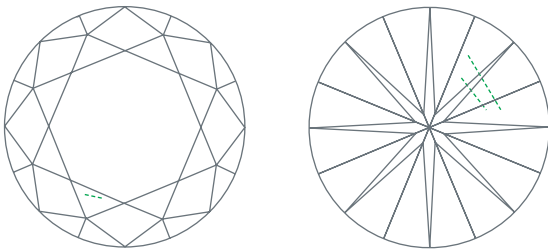

Surface graining that is somewhat easy to see at 10X may be found on a diamond with a Very Good polish. And a diamond with Good polish may have surface graining that is very easily seen at 10X.

Surface Graining plot

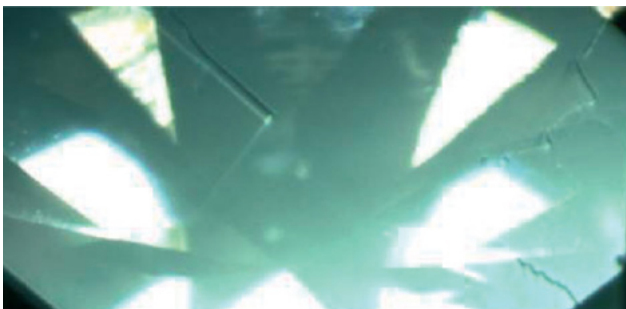

Surface Graining

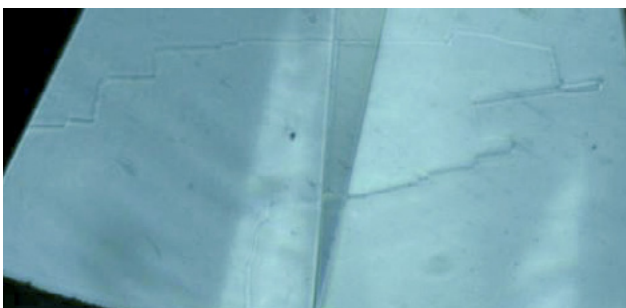

Surface Graining

2.4.2.5 Fair and Poor polish features

Polish grades of Fair or Poor can result from poor craftsmanship in manufacture or subsequent damage. Heavy burn and broken culets are examples of these.

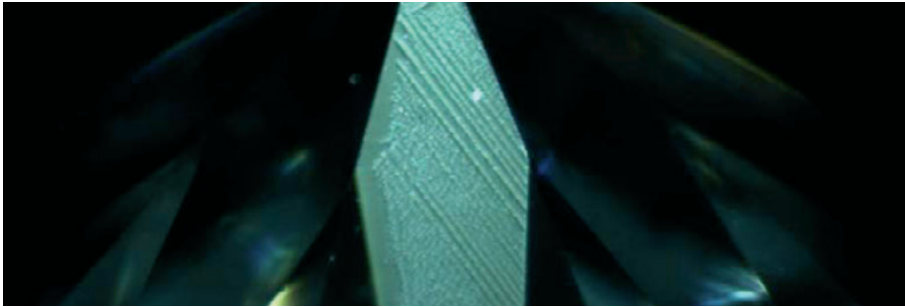

Heavy Burn and Polishing Lines

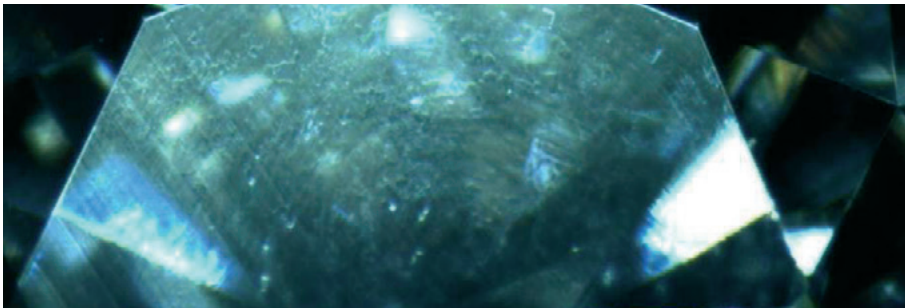

Burn

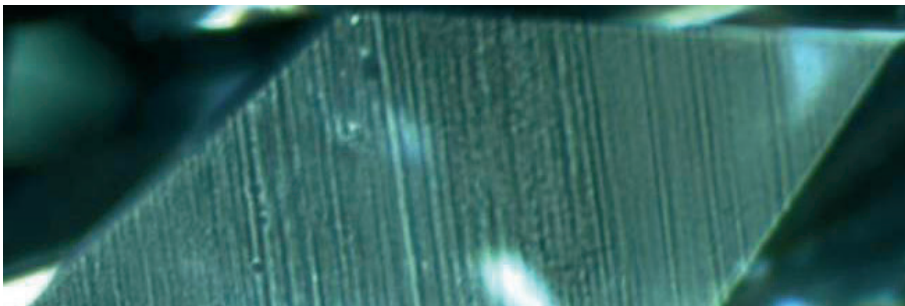

White Polishing Lines

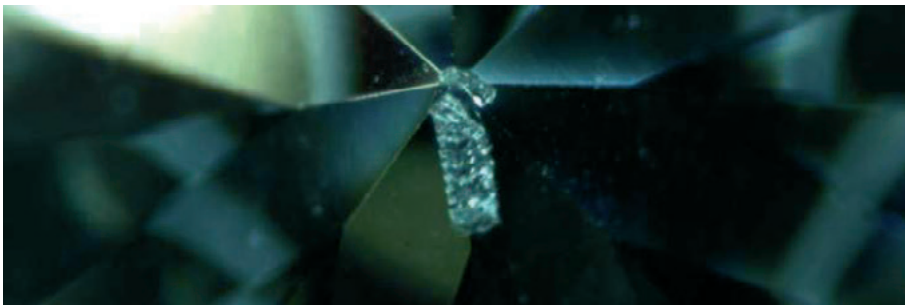

Broken Culet

2.4.2.6 Symmetry grading

Five grades of symmetry come from comparison of a diamond's regularity of facet shape and placement to the 'blueprint' of a 57 facet round brilliant, standard princess cut or other standard fancy shapes. Individual facets and facet groups should be of uniform size and shape and should approximate those expected on a given style of cutting. Out of place extra facets and naturals are considered equally and exclusively as symmetry features. Faceted and natural culets are also considered in proportions.

Diamonds with Excellent symmetry are expected to be relatively free of naturals and extra facets. A minute example of either, however, may be allowed next to the girdle on the pavilion. Minor extra facets and naturals are not allowed on the crown of a Very Good symmetry diamond and those on the pavilion may not be visible in the face up position.

De Beers Group Institute of Diamonds also assesses Painting and Digging in symmetry grading. The girdle on a well made diamond has an evenly scalloped girdle and is expected to have 16 Mountains or Hills of equal thickness as well as 16 Valleys of equal thickness. Girdle thickness variation due to painting or digging is assessed directly in symmetry as girdle variation and therefore only indirectly affects a diamond's cut grade. However those diamonds with painting or digging so severe as to affect a diamond's durability or its brilliance to the unaided eye are subject to a lowering of overall cut grade.

Indented naturals are ordinarily clarity features and are not considered in symmetry grading. However large or obvious indented naturals can be considered in both symmetry and clarity grading.

| | | SYMMETRY GRADE | | | | |
|-----------------|--|---|---|---|--|--|
| | | Excellent | Very Good | Good | Fair | Poor |
| Degree | | Slight | Minor | Noticeable | Obvious | Very Obvious |
| 10X Visibility | | Difficult | Somewhat Easy | Easily Seen | Readily Seen | Eye Visible |
| Characteristics | | Twist Pointing Girdle Variation < 100% Misshapen Facet | Out of Round Table Distortion Girdle Variation 100 - 200% Table / Culet Twist Extra Facets / Naturals in Girdle / on Pavilion Off Centre Misshapen Facet Pointing Open Culet Bezel / Pavilion Alignment | Out of Round Table Distortion Girdle Variation 200 - 300% Table / Culet Twist Extra Facets / Naturals Misshapen Facet Pointing Open Culet | Out of Round Missing Facet Girdle Variation 300 - 500% Table Distortion Table / Culet Extra Facets / Naturals Misshapen Facet Twist Pointing | Out of Round Missing Facet Girdle Variation > 500% Table Distortion Table / Culet Extra Facets / Naturals Misshapen Facet Twist Pointing |

Symmetry grade features

2.4.2.6 Symmetry features

Examining a polished diamond for its Symmetry, graders use a series of cues to accurately decide its overall Symmetry grade. De Beers Group Institute of Diamonds' symmetry check list of the following characteristics quickly determines grades of Excellent, Very Good, Good, Fair or Poor.

Twist

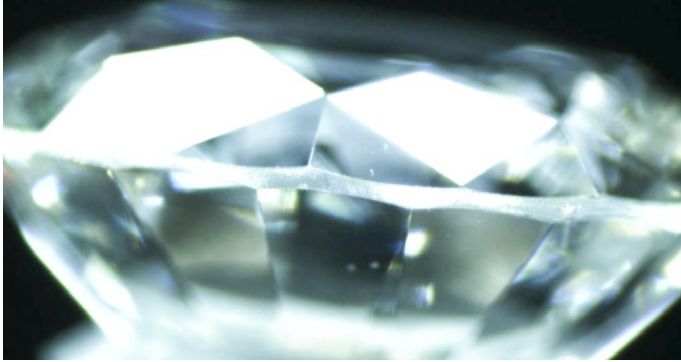

Twist is the misalignment of upper and lower girdle facets and their junctions across the girdle.

Pointing

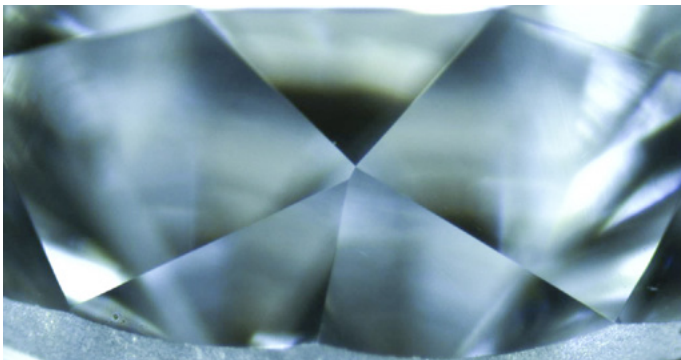

Three facet junctions on a polished diamond should form a point and not a line, as well for the culet, an eight facet junction. The crown and girdle provide the best areas for a quick check for Pointing.

Girdle Variation

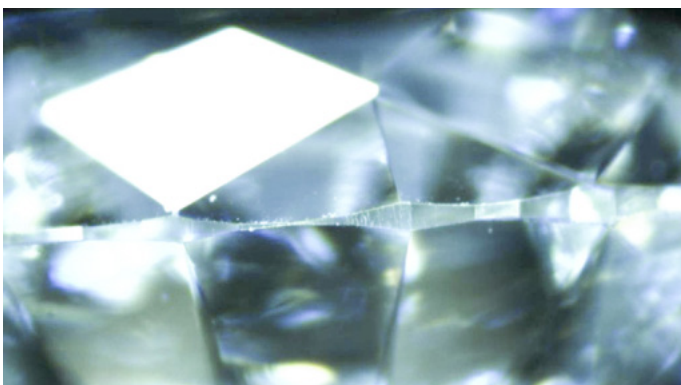

A view of the regularity of thickness of diamond's girdle provides a quick check for symmetry. This can indicate variations in angles of upper and lower girdle facets as seen with pointing and digging.

Girdle Facets' Rib

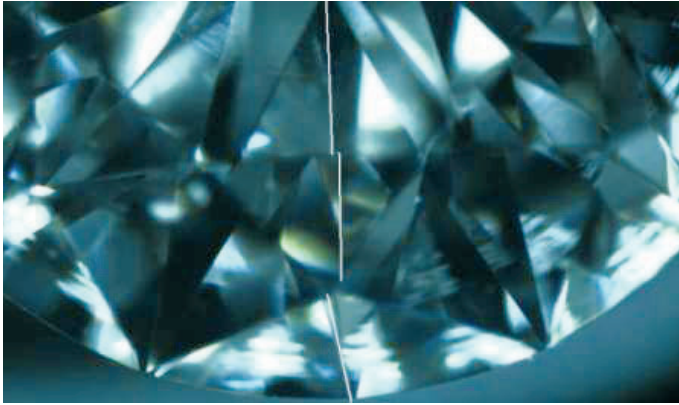

Girdle Facets' Rib is misalignment of upper and lower girdle facet ribs through the stars as seen through the crown. This symmetry feature appears when the polisher overcomes twist by aligning crown and pavilion brilliandeering yet introduces this symmetry fault in its place. This can also be graded as Misshapen Facet as upper girdle facets become distorted.

Misshapen Facet

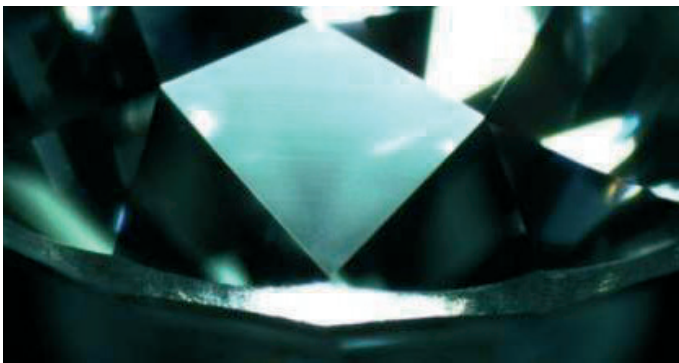

As implied, Misshapen Facets affect a polished diamond's symmetry grade. A quick check of bezel facets also shows the relative regularity of the adjacent stars and upper girdle facets.

Natural

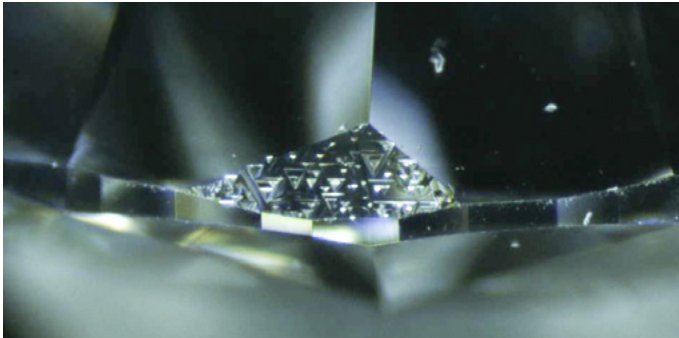

A Natural is the original surface of a rough crystal left unpolished. Unexpected on diamonds with Excellent symmetry, naturals interfere with symmetry by distorting any of its adjacent facets or the girdle.

Bezel Pavilion Alignment

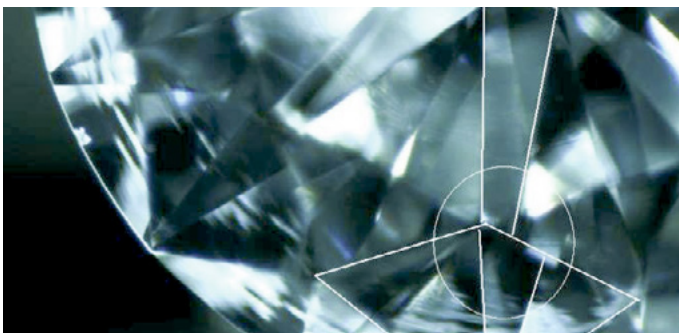

View through the upper and lower points of a Bezel facet checking alignment with its corresponding Pavilion facet. This indicates a diamond's symmetry fault in cross, before brilliandeering.

Table Distortion

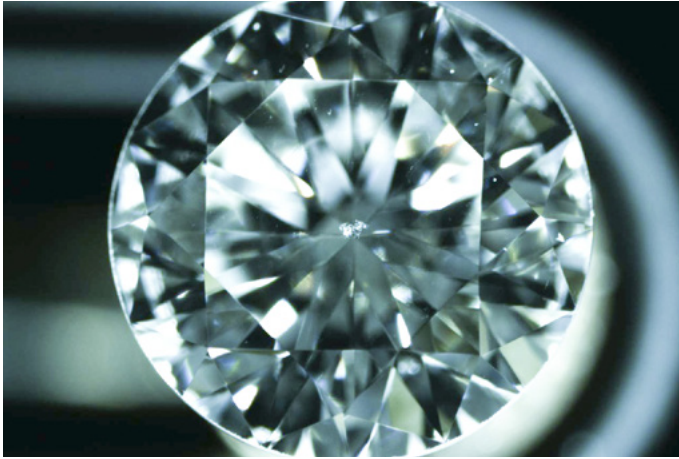

A quick check for the symmetry of a polished diamond's table is to view the two boxes of stars that form the edges of the table.

Extra Facet

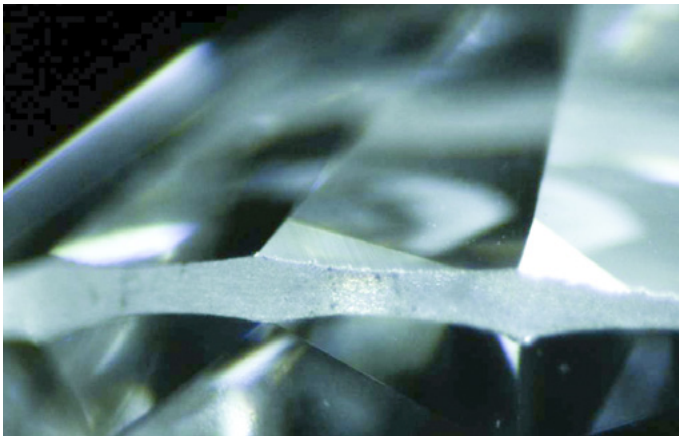

An Extra Facet is one placed on a polished diamond without regard to the regular facet arrangement on a particular style of cut. Out of place, its number, size and location help determine a diamond's symmetry. An Excellent does not have an extra facet on its crown for example and one on its pavilion must be minute and very difficult to see at 10X. Extra facets are graded in the same manner as naturals in symmetry.

Roundness

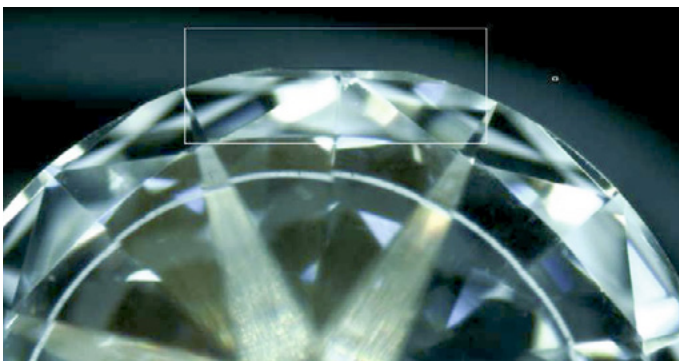

A round brilliant should be round, and fancy shapes should have a regular, symmetrical profile. A quick check with the loupe shows any irregularities. Related to roundness is a conic girdle not finished perpendicular to a diamond's table.

Unclosed Culet



When all pavilion facets don't meet exactly in a point the result is a culet that is not properly closed. This shows as bright spots between pavilions near the culet when viewing through the table.

Culet / Table Alignment

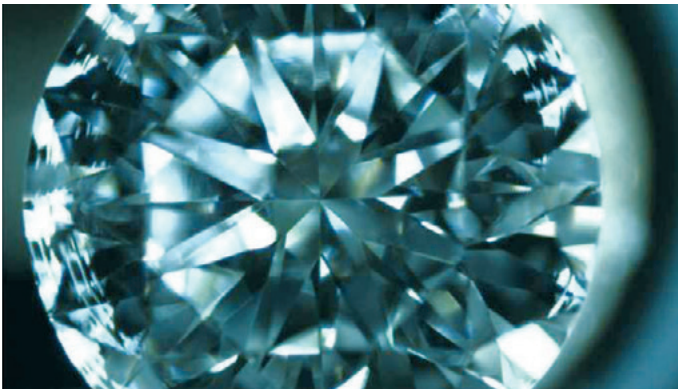

A quick view with the loupe shows if the culet is located directly below the centre of the table. Bezel -Pavilion alignment checks may also provide a clue to an off centre culet.

Lower Girdle Facet

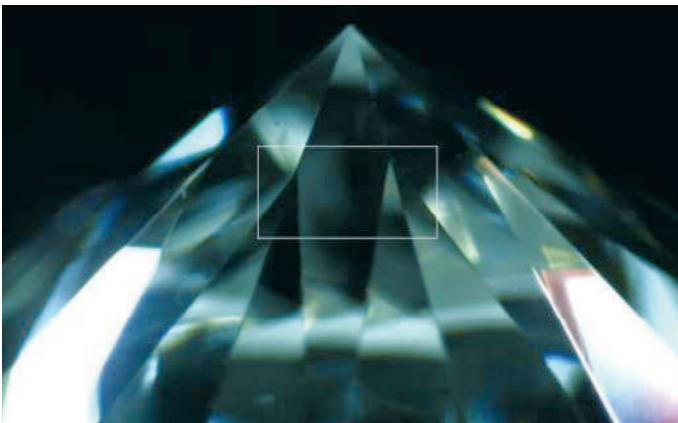

In viewing a diamond in the table down position on the microscope a grader's symmetry assessment includes checking lower girdle facets for equality in length, both individually and in pairs, and proper pointing.

2.4.2.7 Naturals and symmetry grading

A Natural is the 'skin' of the original rough diamond crystal untouched during polishing. Such traces of the original rough are proofs that a diamond has been manufactured to its maximum dimension. Polishing away a natural obviously finishes a smaller diamond.

As diamonds are priced per carat, naturals can sometimes pose a problem for the polisher. At times there is no option like when the choice is to polish away the natural and finish 4.85 carats or leave it and finish the much more valuable 5 carater.

A natural is treated in symmetry in the same way as an extra facet.

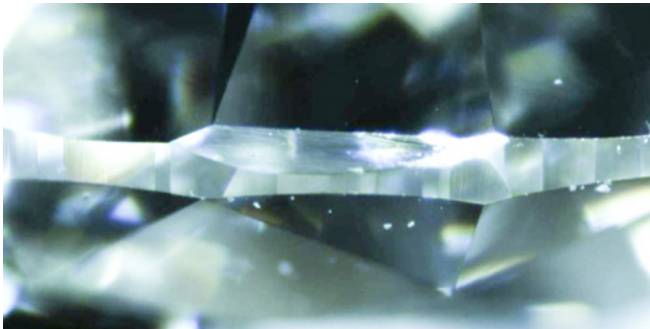

On the blueprint for a standard round brilliant there is no natural (or extra facet) thus the expected symmetry of a brilliant with a natural is changed. To further the comparison, a natural can easily be polished away with an extra facet or two in minimum time and with insignificant weight loss.

Natural

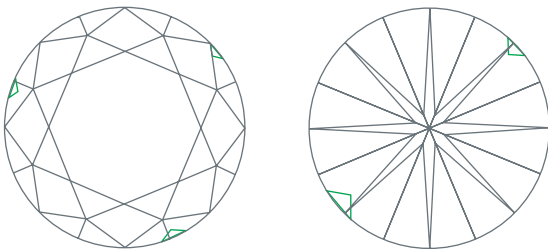

Naturals are plotted using the correct size and location of the green icon.

Natural plot



On VVS2 and better, naturals confined to the girdle may be plotted using the green N icon. Naturals located entirely in the girdle are plotted slightly outside the diagram, nearest their location, on the crown side only using the N icon. These naturals can have a symmetry effect upon a diamond's roundness or regular profile in the case of fancy shapes.

N type Natural

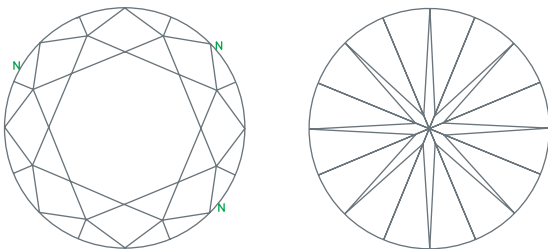

N type Natural plot

2.4.2.8 Large indented naturals and symmetry grading

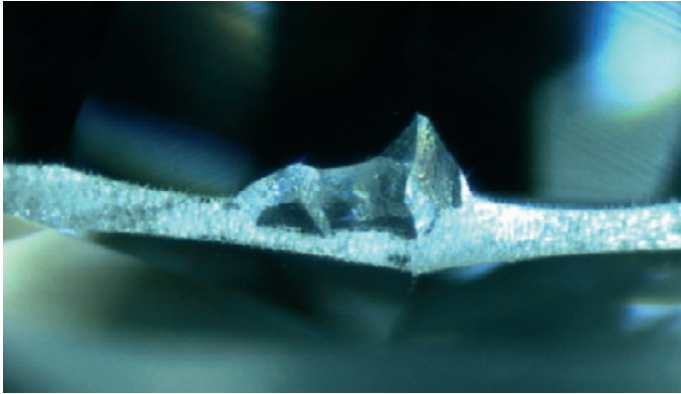

Large indented naturals are plotted by adjusting the green natural triangle to approximate its size and inserting the large indented natural icon. Large indented naturals are considered in both clarity and symmetry grades.

Large Indented Natural – Symmetry and Clarity considerations

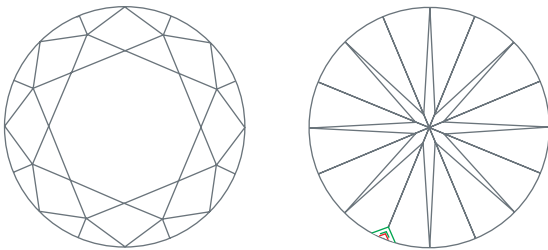

Large Indented Natural plot

2.4.2.9 Painting and digging and symmetry grading

De Beers Group Institute of Diamonds considers Painting and Digging a symmetry fault as girdle variation.

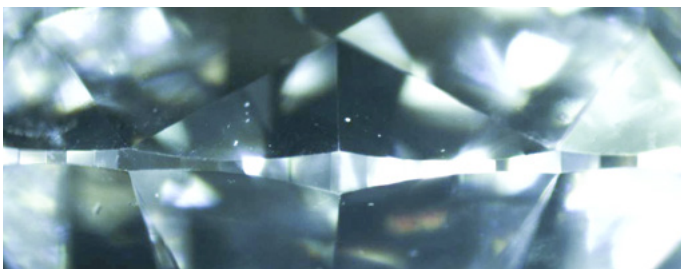

Painting

In a form of brilliandeering called Painting a polisher may decide to retain weight by very lightly polishing the upper and/or lower girdle facets.

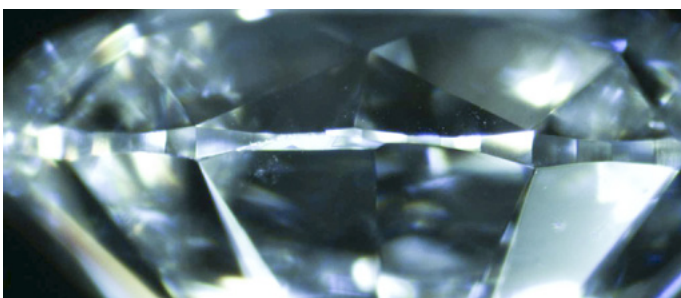

Digging

In Digging a polisher may remove naturals or other unwanted features by polishing the same facets deeper into the girdle than otherwise necessary.

Symmetry is always affected either locally or generally by these processes on a polished diamond. Because of its more negative effect upon a diamond's light performance, digging is graded more severely than painting in symmetry grading.

The quick check is to view the regularity of the 16 *Hills* and 16 *Valleys* around the girdle. A painted diamond's upper-lower girdle facet girdle junction is thicker than its bezel-pavilion junction. Conversely a dug out diamond's bezel-pavilion junction is thicker.

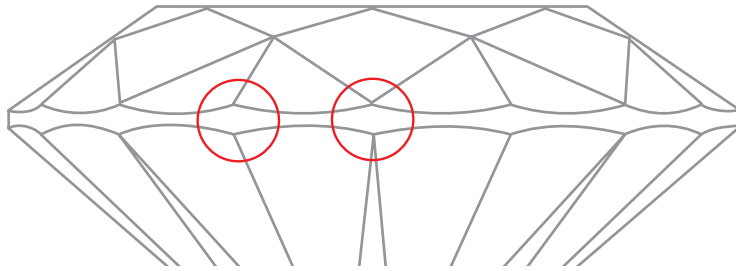

Well formed girdle: Upper girdle-lower girdle junction = bezel-pavilion junction

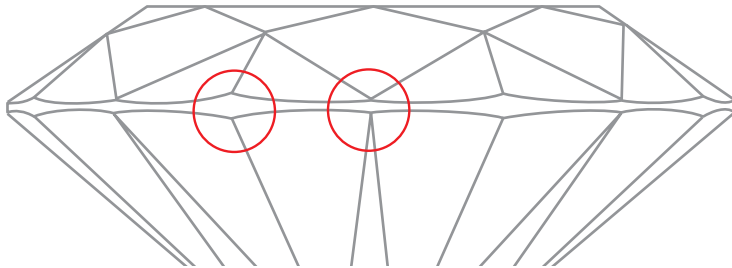

Painting: Upper girdle-lower girdle junction is thicker than bezel-pavilion junction

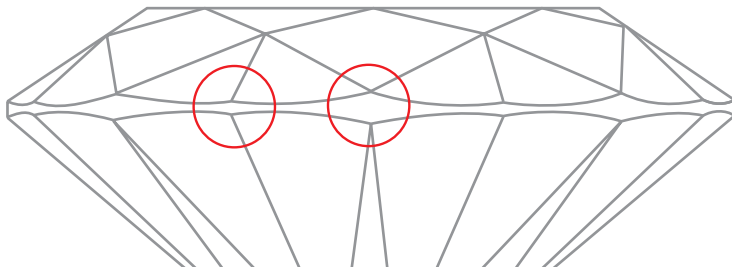

Digging out: Upper girdle-lower girdle junction is thinner than bezel-pavilion junction

3 De Beers Group Institute of Diamonds and laser

3.1.1 Laser and clarity enhancements

3.1.1.1 Laser drill

A diamond with a prominent black included crystal may be drilled with a laser. This exposes the crystal to an etching acid in a subsequent boiling process that eliminates any non-diamond material and leaves

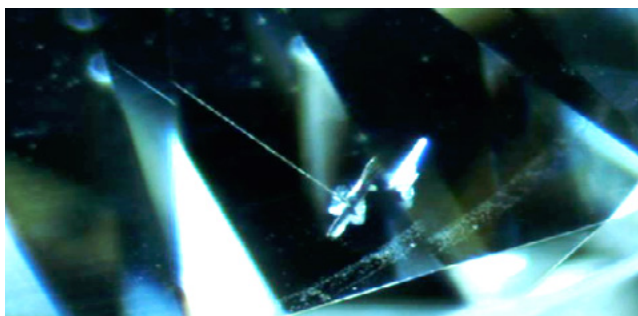

a whitish void in its place. Laser drilling is a permanent process that leaves damage to the diamond in the form of the drill hole often accompanied by burn on the entry facet. Considered a Clarity enhancement treatment laser drilled diamonds are excluded by De Beers Group Institute of Diamonds.

Laser drilled diamond

3.1.1.2 KM

KM treatment is a permanent process that reduces the amount of contrast on a totally included black or coloured crystal. This is an alternative process to the more obvious laser drilling that also aims to reduce the contrast of included crystals. KM is the shortened form of Hebrew Kiduah Meyuhad, or special drilling. In KM a laser is focused upon an included crystal to heat it until it explodes. Fractures or feathers radiating from the exploded crystal are meant to reach the surface of the diamond exposing the original crystal to dissolve in etching acids used in subsequent boiling. KM however causes

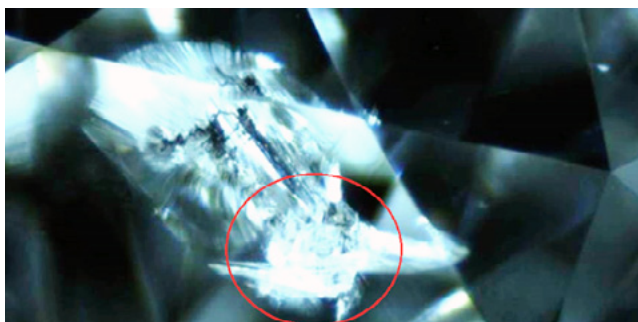

considerable damage to the diamond with its induced fractures. Identifying features are the feathers around the exploded crystal as well as around the black worm hole-like tunnel that can reach the surface of the diamond. Considered a Clarity enhancement treatment KM diamonds are excluded by De Beers Group Institute of Diamonds.

KM with target crystal

3.1.1.3 Lasers in diamond manufacture

Lasers have taken a prominent role in diamond manufacture over the last 20 years. These processes include laser marking of rough in the planning stage, laser rough sawing, and laser girdle marking. Laser rough marking is done to indicate the planner's decisions on how to manufacture a crystal and is more permanent than ink as used in the past. Laser girdle marking indicates the limits of faceting at the girdle to the polisher. All traces of these processes should be polished away in finishing the diamond.

When remnants of these types of lasering remain on the surface of a polished diamond its Polish grade may be affected in the following ways.

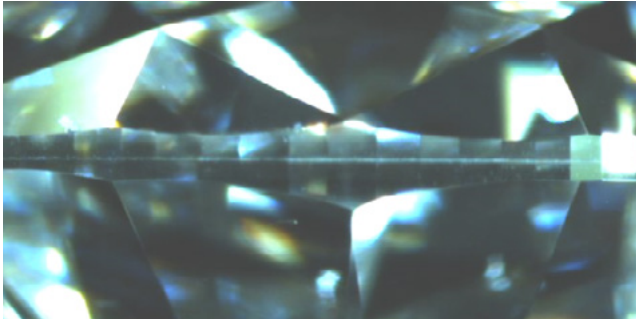

Laser Girdle Marking - Polish

Laser girdle marking may lower a diamond's Polish grade from Excellent to Very Good. In very rare cases a Polish grade may lower to Good because of excessive laser girdle marking left on a diamond.

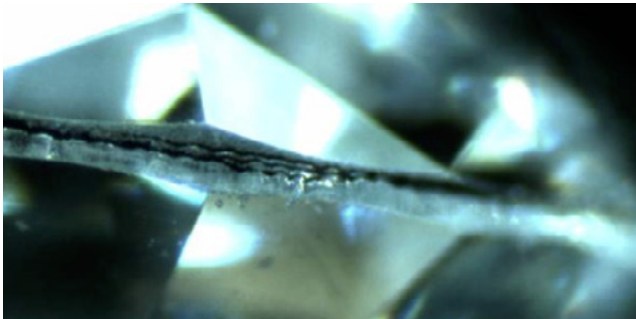

Deep Laser Girdle Marking Remnants - Clarity

Deep laser girdle marking – seen to penetrate the diamond while viewing face up – can also be graded in Clarity as open feathers.

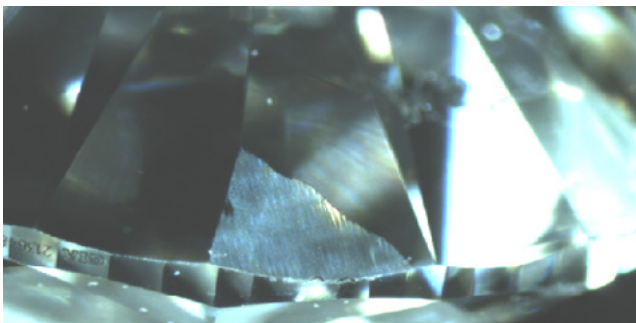

Laser Sawing Remnants – Symmetry and Polish

Laser sawing remnants are graded in both Symmetry and Polish in the same way as a badly burned extra facet.

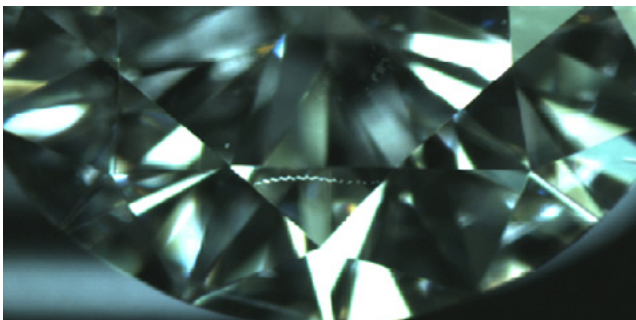

Laser groove on star facet - Clarity

Laser grooves left fully on a facet are graded in Clarity as feathers.

3.1.2 Penetrative, internal laser accidents

There are two different types of lasers used in diamond manufacturing. One is a high power laser used for dividing or sawing rough in a straight forward burning process. The other type of laser, intended

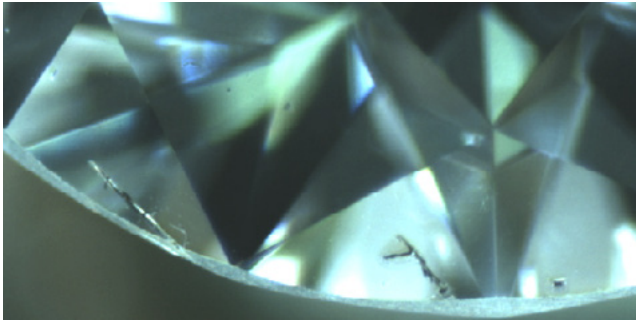

for marking the surface of diamonds, has a different light source. Accidents can happen using this light source when reflections change the laser's focus from the diamond's surface to its interior. These accidents form internal damage that affect a diamond's clarity.

**Internal Laser Manufacturing Remnants from Girdle Marking
- Clarity**

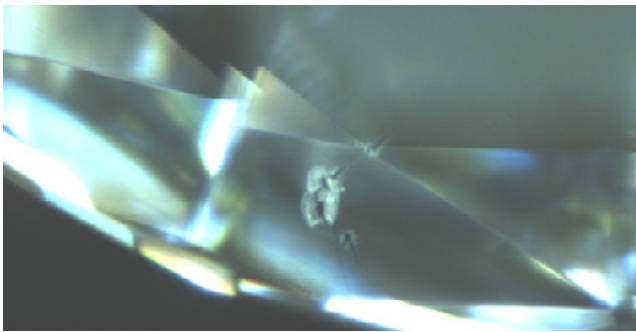

The damage caused by these laser accidents is the same as that caused by KM attempts to enhance diamond clarity. When there is no target inclusion to explain a possible KM treatment De Beers Group Institute of Diamonds grades these accidents as Internal Laser Manufacturing Remnants in Clarity in the same way as crystals or other internal features.

**Internal Laser Manufacturing Remnants from Rough Marking
- Clarity**

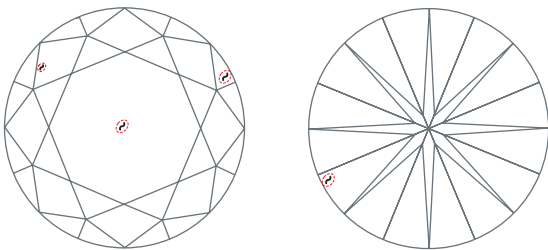

Figure – Internal Laser Remnant Plot

4 Diamond Grading Report

4.1.1 The 4Cs of diamonds

The appeal of diamonds is complex. It blends visual, tactile and associative qualities in a glittering microcosm of eternity. On a practical level, it is our gemmologists' responsibility to impose a rational approach to the stones they consider. Using specially developed proprietary instruments and technology, they impartially assess every diamond according to criteria based on the '4Cs':

4.1.2 Grading summary

| Summary | |
|--------------------|----------------------|
| Inscription Number | 000000 |
| Shape | Round |
| Measurements | 5.19 - 5.22 x 3.20mm |
| Carat | 0.53 ct |
| Colour | H |
| Clarity | VS2 |
| Cut | Excellent |
| Polish | Excellent |
| Symmetry | Excellent |
| Fluorescence | Negligible |
| Comments | |

The first panel depicts the seal of the De Beers Group Institute of Diamonds proving that the diamond was graded at one of the Institute's laboratories. Below this, is the Grading Report summary listing the diamond's inscription number, shape, measurements and carat weight along with grades for colour, clarity and cut.

4.1.2.1 Colour

We grade all colours of diamonds using the single letter grade system D through N, double letter grades from O-P through Y-Z in yellow, plus all fancy colours. K, L and M equivalent other hues are described as Faint; N through R equivalents are Very Light, and S through are called Light, such as Light Yellowish Green. In terms of Fluorescence we grade from Negligible through to Very Strong. On our Diamond Grading Report you will find the colour section on the 3rd panel.

4.1.2.2 Clarity

A maximum of 4 different features' symbols or icons appear on the plot though more than 4 of any of these features may appear when necessary to justify a grade. Included on this panel are comments such as Additional pinpoints not shown or Grade based upon cloud when such a comment is more appropriate than a plotted clarity icon. Internally Flawless diamonds are accompanied by the comment Minor details of Polish not shown. Our Diamond Grading Report contains a plot diagram of both crown and pavilion upon which clarity features are represented in their approximate size and location. When present on the diamond the Symmetry features Naturals and Extra Facets may also be plotted. This section is found on the 2nd panel of the report.

4.1.2.3 Cut grade

The Cut grade shows the diamond in profile with its relevant proportion parameters of table percentage; crown angle and height percentage; girdle thickness; pavilion angle and depth percentage; and the overall depth percentage. A diamond's overall cut grade combines its proportions with its polish and symmetry grades, these two grades are also represented. Fancy shapes have their polish and symmetry grades recorded without cut grade. You will find this section on the 3rd panel of the Diamond Grading Report.

4.1.2.4 Carat

For a Round Brilliant, the Carat weight is reported as minimum diameter, maximum diameter, and height in millimetres, on all grading reports. Fancy Shape diamond measurements are reported as length, width and height in millimetres. These are depicted on the 2nd panel of the Diamond Grading Report.

Sample De Beers Group Institute of Diamonds Grading Report



DE BEERS GROUP
INDUSTRY SERVICES

Carat 0.53ct

Carat Weight
0.53 ct

Measurements
5.19 - 5.22 x 3.20mm

Colour H

Colour Grade

| | | | | | | | | | | |
|---|---|---|---|---|---|---|---|---|---|---|
| D | E | F | G | H | I | J | K | L | M | N |
|---|---|---|---|---|---|---|---|---|---|---|

| | | | | | |
|----|----|----|----|----|----|
| OP | QR | ST | UV | WX | YZ |
|----|----|----|----|----|----|

Your Grading Report Number: SAMPLE
Date: dd/mm/yyyy: 9/11/2018

Summary

Inscription Number: 000000

Shape: Round

Measurements: 5.19 - 5.22 x 3.20mm

Carat: 0.53 ct

Colour: H

Clarity: VS2

Cut: Excellent

Polish: Excellent

Symmetry: Excellent

Fluorescence: Negligible

Comments:

Clarity VS2

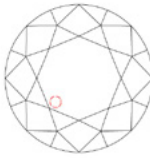
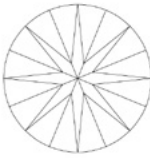
Clarity Grade

| | | | | | | | | | | |
|----|----|------|------|-----|-----|-----|-----|----|----|----|
| FL | IF | VVS1 | VVS2 | VS1 | VS2 | S11 | S12 | I1 | I2 | I3 |
|----|----|------|------|-----|-----|-----|-----|----|----|----|

Symbols: Cloud (red circle)

Comments:

Fluorescence: Negligible

Cut Excellent

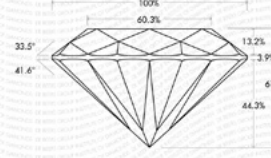

Cut Grade

| | | | | |
|-----------|-----------|------|------|------|
| EXCELLENT | VERY GOOD | GOOD | FAIR | POOR |
|-----------|-----------|------|------|------|

Shape: Round



Polish: Excellent

Cut Grade: Excellent

Symmetry: Excellent

Grading natural untreated diamonds exclusively.
Accurate, consistent, transparent, confidential.

This report is securely protected in accordance with diamond industry guidelines using holographic and microprint technology.
Learn more and access the report check at:
www.debeersgroupservices.com

5 Clarity treatments

In addition to testing using DeBeers state of the art instruments including DiamondSure™, DiamondView™, and DiamondPlus™ for detection of HPHT and synthetic diamonds, De Beers Group Institute of Diamonds graders are alerted for clarity or colour enhancements while grading. Such enhancements include laser drilling, fracture filling and colour coating and, like synthetics and HPHT treated diamonds, are excluded by De Beers Group Institute of Diamonds.

5.1.1 KM

KM treatment is a permanent process that reduces the amount of contrast on a totally included black or coloured crystal. KM is the shortened form of Hebrew Kiduah Meyuhad, or special drilling. In KM treatment lasers are focused upon included crystal to heat it until it explodes. Fractures or feathers radiating from the exploded crystal are meant to reach the surface of the diamond exposing the original crystal to dissolve in etching acids used in subsequent boiling. KM however causes considerable damage to the diamond with its induced fractures. Its identifying features are the feathers around the exploded crystal as well as around the black worm hole-like tunnel that can reach the surface of the diamond.

Diamonds with KM are excluded from De Beers Group Institute of Diamonds.

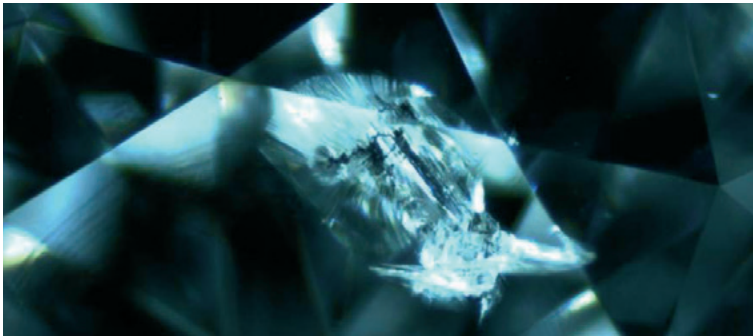

KM laser

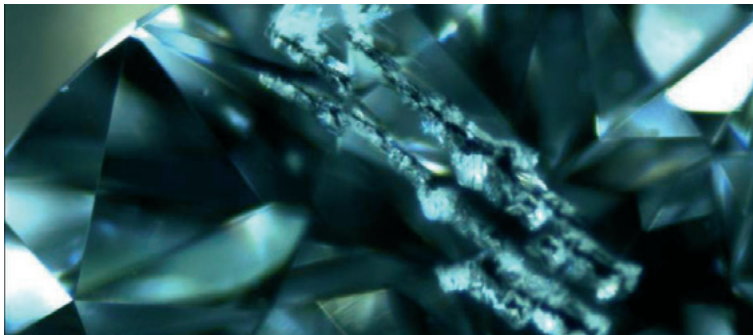

KM laser

5.1.2 Fracture filling

Fracture filling is a process in which a glass-like material with a refractive index similar to diamond's is injected into a diamond's cleavage, feather or other surface reaching feature to improve its visual appearance or mask this feature.

Filling can be detected by colour flashes from the filled areas. Small bubbles or flow patterns may also be detected in filled areas. Fracture filling is not a permanent treatment as filling materials may deteriorate over time and can be boiled out in acid.



Fracture filled



Fracture filled

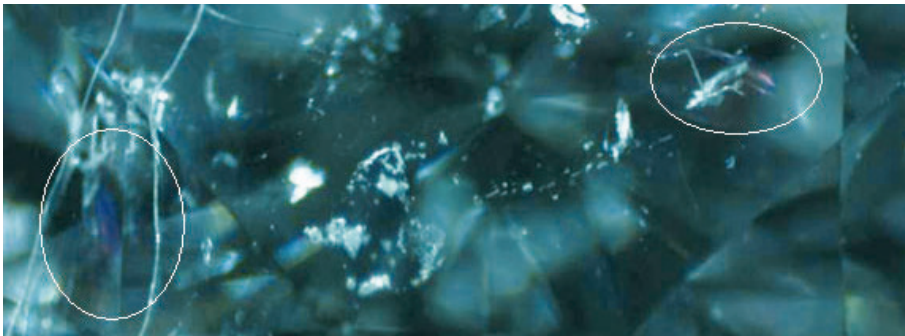

Fracture filled

5.1.3 Laser drilling

A diamond with a prominent black included crystal may be drilled with a laser. This exposes the crystal to an etching acid in a subsequent boiling process that eliminates any non-diamond material and leaves a whitish void in its place.

Laser drilling is a permanent process that leaves damage to the diamond in the form of the drill hole often accompanied by burn on the entry facet. Laser drilled diamonds are excluded by De Beers Group Institute of Diamonds.

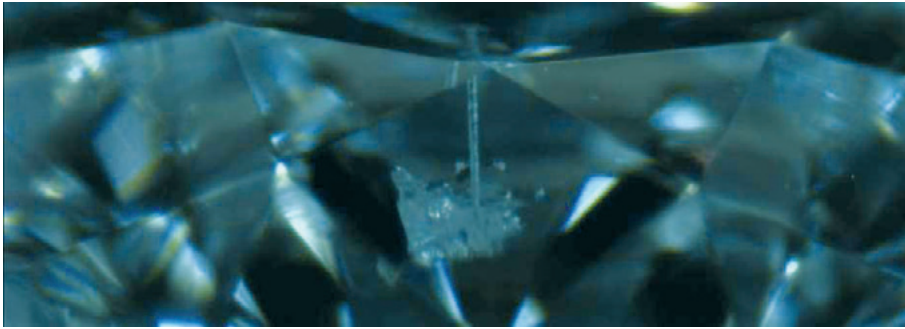

Laser drilled



Laser drilled with burn on entry facet

5.1.4 Coating

In order to improve the colour or visual appearance of a polished diamond, Coatings can be applied. Detection involves viewing with an emphasis upon the surface rather than the interior of the polished diamond. In these examples a coating has been used to impart a pink appearance to the polished. Much softer than diamond, the coating is easily abraded on facets and facet edges and thus easily detected.

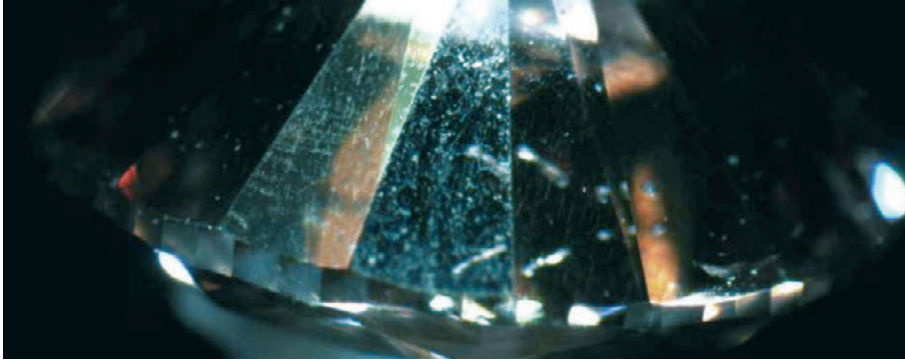

Colour Coating treatment



Colour Coating treatment

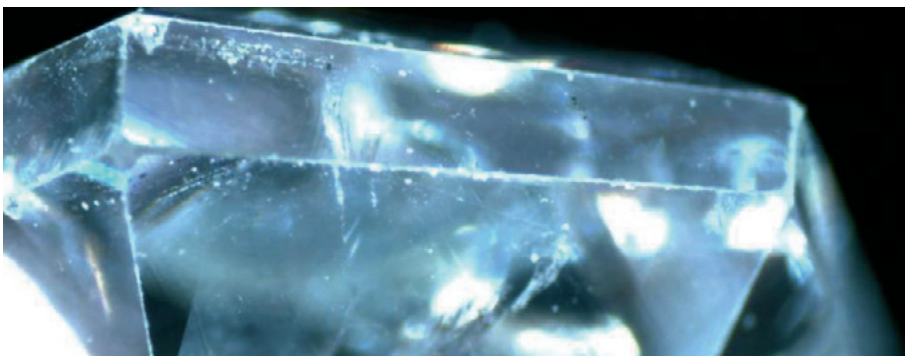

Colour Coating treatment

6 Summary

De Beers Group Institute of Diamonds has set standards for size, colour, quality and craftsmanship for polished diamonds in order to best fulfil its promise to the discerning consumer, while expressing these standards clearly to the participating diamantaire. These completely natural and untreated diamonds conform to today's high standards for light performance.

Technology provides support in areas of treatment detection, proportion grading, colour grading as well as a production flow system that assures anonymity of a diamond's ownership to all personnel involved in grading.

As products of nature, diamonds resist being quantified or categorized to any absolute degree. However with its clear definitions of features and characteristics, strict sets of rules in assessments of the 4Cs, De Beers Group Institute of Diamonds achieves a grading level of accuracy and consistency far surpassing that of other institutes throughout the world.

7 Change log

The International Institute of Diamond Grading & Research (IIDGR) Grading Standards Version 1.0 was published in September 2015. Below is a log of subsequent changes.

IIDGR Grading Standards Version 1.1 January 2016

| | |
|----------|--|
| Appendix | Elimination of Very Good proportions for 66% table |
|----------|--|

IIDGR Grading Standards Version 1.2 February 2016

| | |
|----------|--|
| Page 28 | Cloudy Internal Graining Table: Table name and column headings changed |
| Page 32 | Min-Max Proportions Table: Max Crown Angle for Excellent grade changed from 36.7° to 36.2° |
| Appendix | Elimination of 41.7° and 41.8° Pavilion Angle from all Excellent proportions |
| Appendix | Elimination of 36.5° Crown Angle from Excellent proportions for 56% table |

IIDGR Grading Standards Version 1.3 January 2017

| | |
|------------|--|
| Throughout | Addition of paragraph numbering |
| Page 58 | Images replaced by diagrams of Painting and Digging out |
| Page 61 | Paragraph about Carat deleted. The part discussing measurement to 6 decimal places moved to 1.1.1 Carat on page 3. |
| Page 63 | Grading Report image corrected to show carat weight to 2 decimal places |
| Page 68 | Change log added |
| Appendix | Addition of page numbering |

IIDGR Grading Standards Version 1.4 October 2017

| | |
|---------------|---|
| Throughout | Remove the term 'milky' from descriptions of Clouds |
| Page 3 | Minimum size 0.10 carat (<i>was 0.14 carat</i>) |
| Page 4 | Remove bullet point about 'no grading re-check service' |
| Page 7 | Corrected: 'graders view the diamond through the pavilion' (<i>was colouring is viewed through the pavilion</i>) |
| Page 16, 42-3 | Updated: new Abrasion and Nick plot icons |
| Page 49 | Added: 'an evenly scalloped girdle' (<i>was 'a well made diamond has a scalloped girdle'</i>) |

De Beers Group Institute of Diamonds Grading Standards Version 1.5 February 2019

| | |
|------------|---|
| Throughout | Rebrand from IIDGR to De Beers Group Institute of Diamonds - new font and logos |
| Page 60/61 | Updated images of Grading Reports (<i>were IIDGR Grading Reports</i>) |

De Beers Group Institute of Diamonds Grading Standards Version 1.6 May 2019

| | |
|--------|--|
| Page 9 | Update: 9 watt bulb for fluorescence grading (<i>was 7 watt</i>) |
|--------|--|

Appendix:

Table, crown and pavilion angle proportions charts

48 percent table

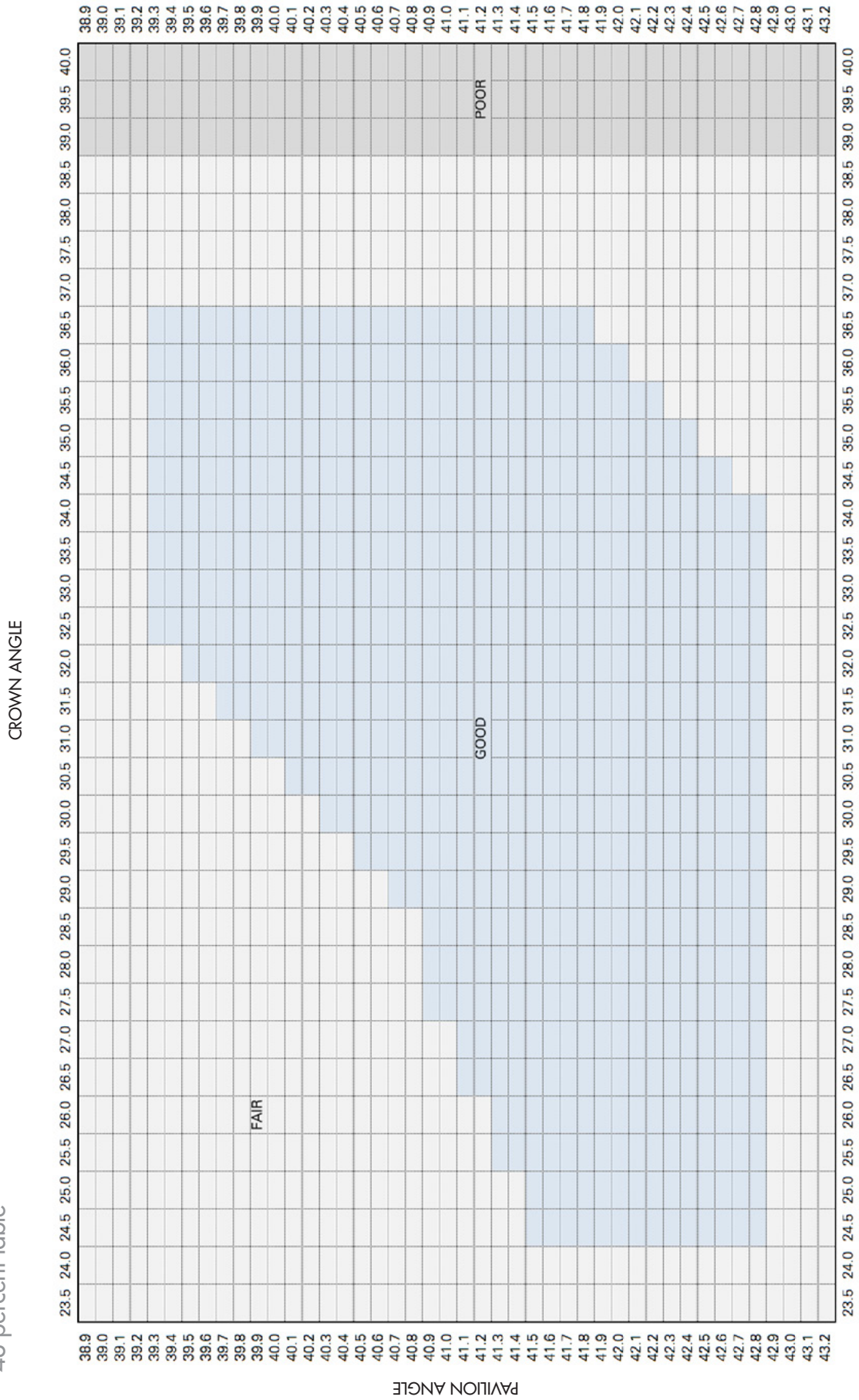

49 percent table

CROWN ANGLE

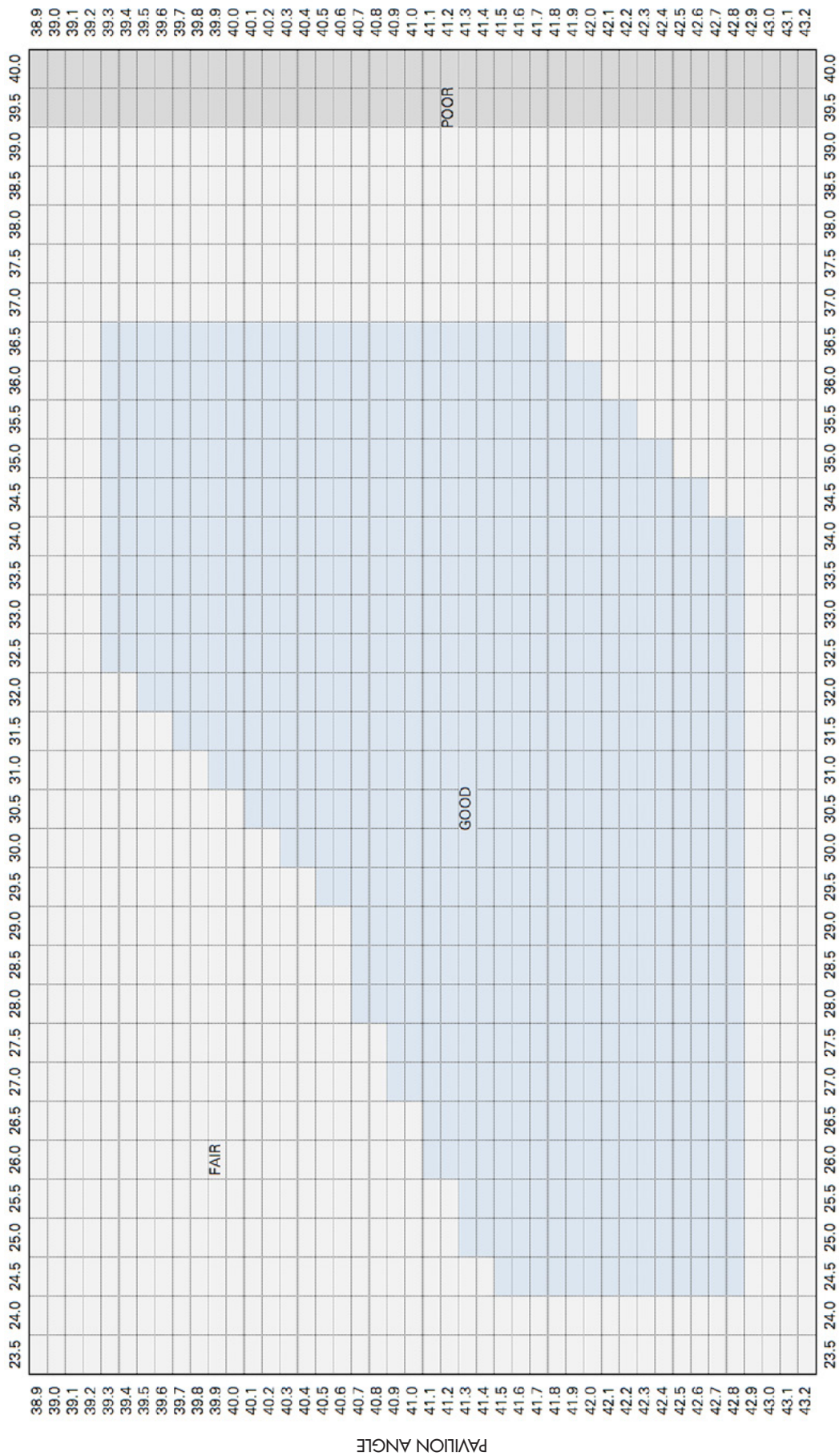

51 percent table

CROWN ANGLE

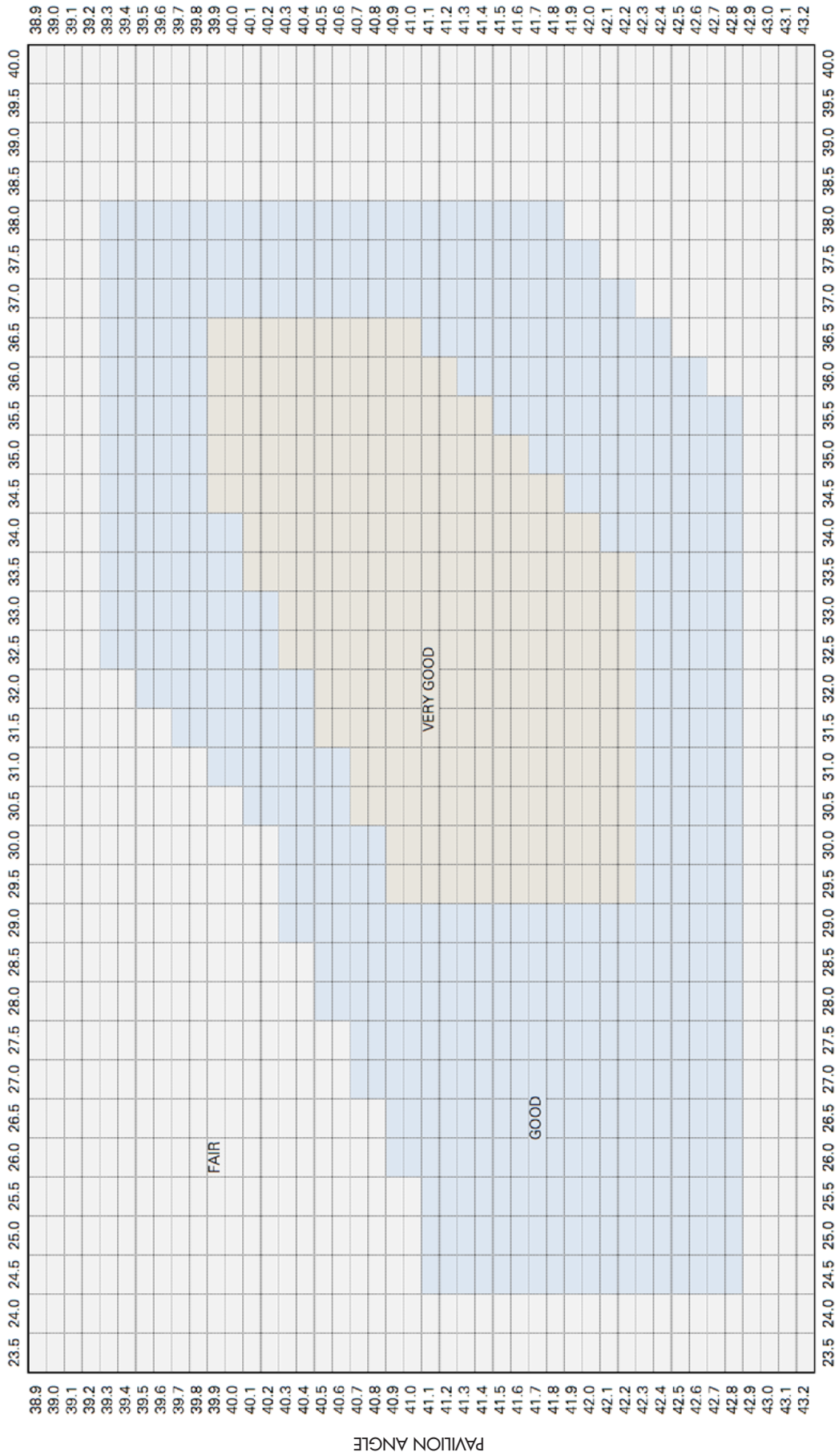

52 percent table

CROWN ANGLE

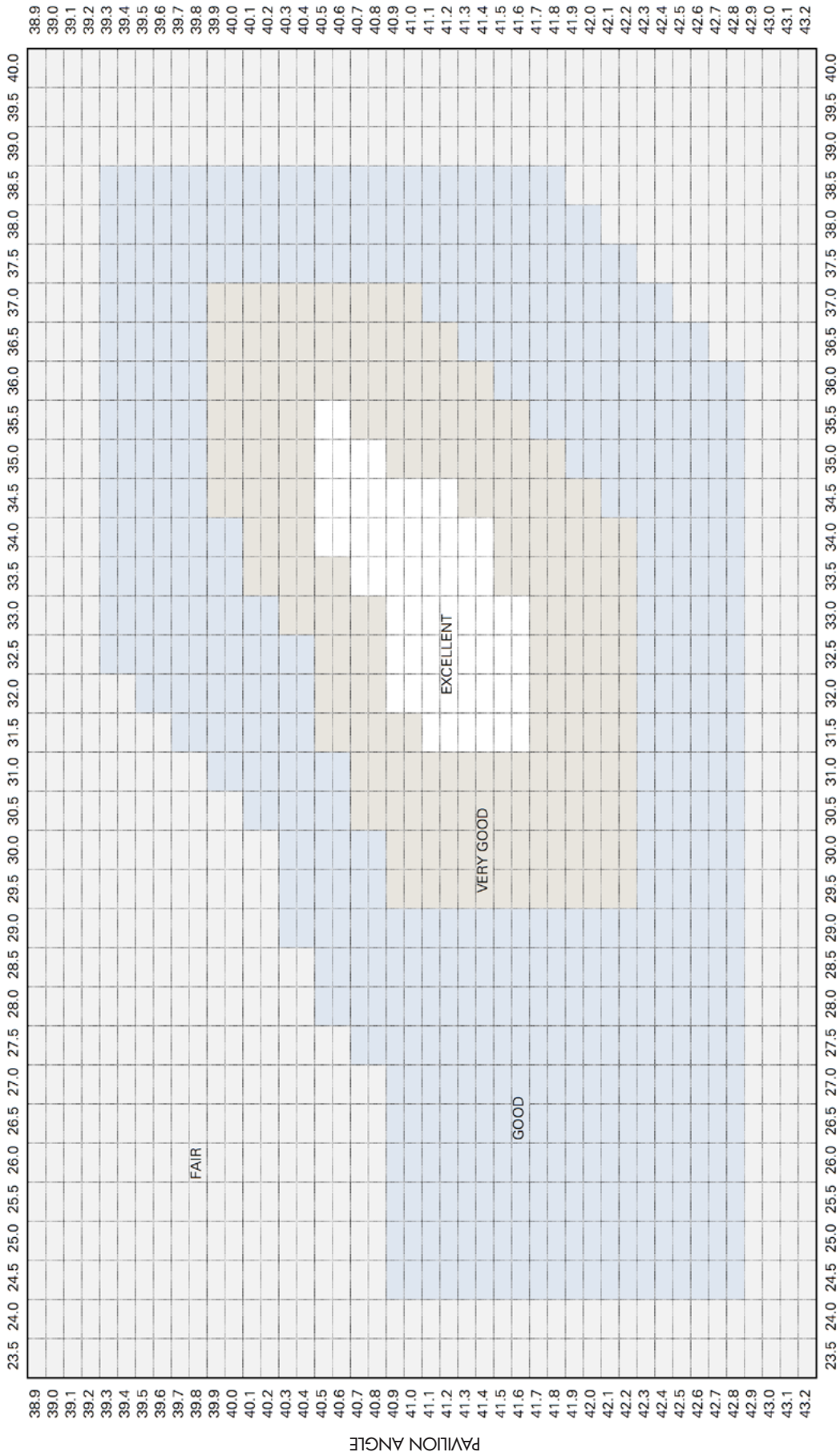

53 percent table

CROWN ANGLE

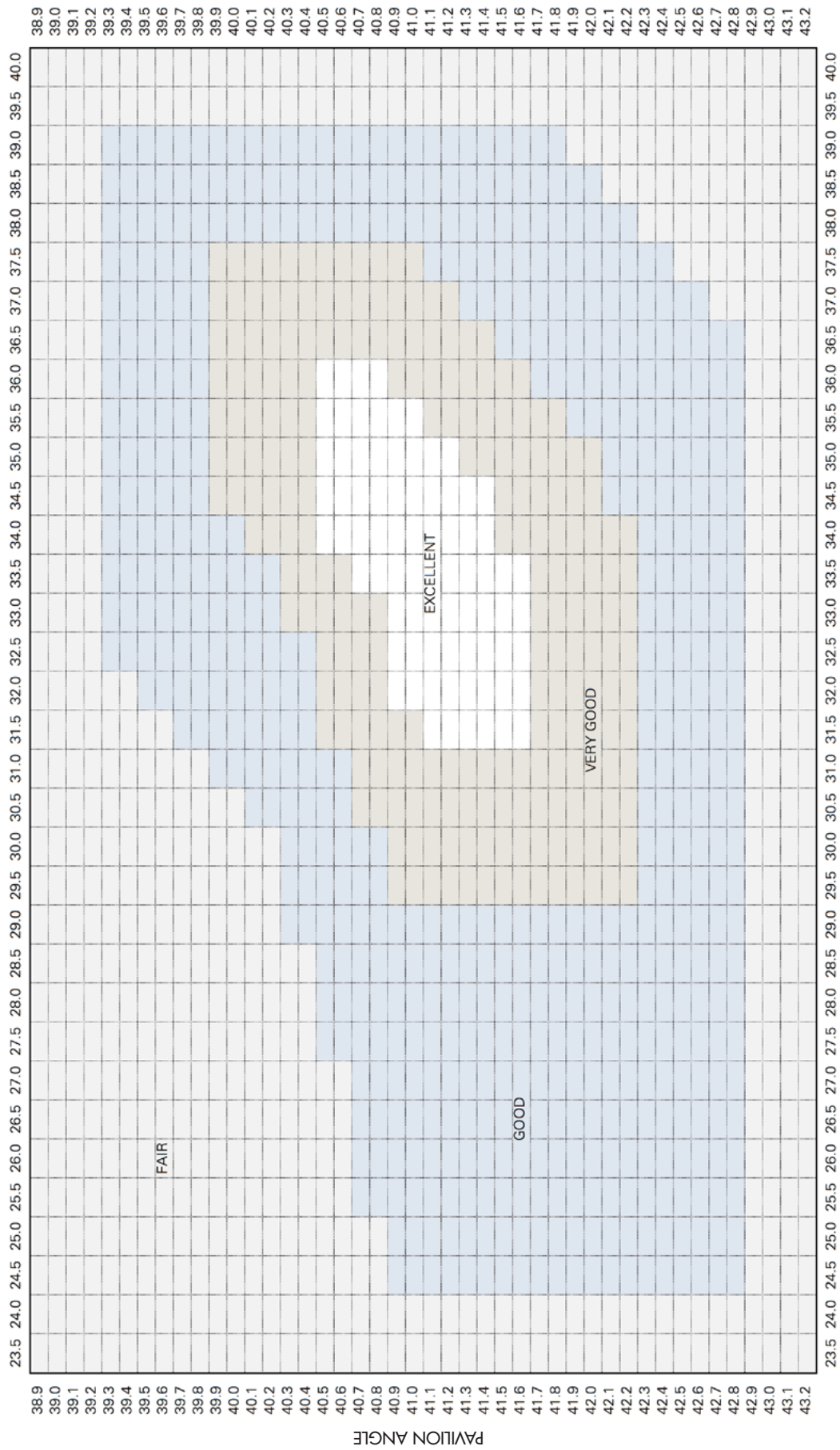

54 percent table

CROWN ANGLE

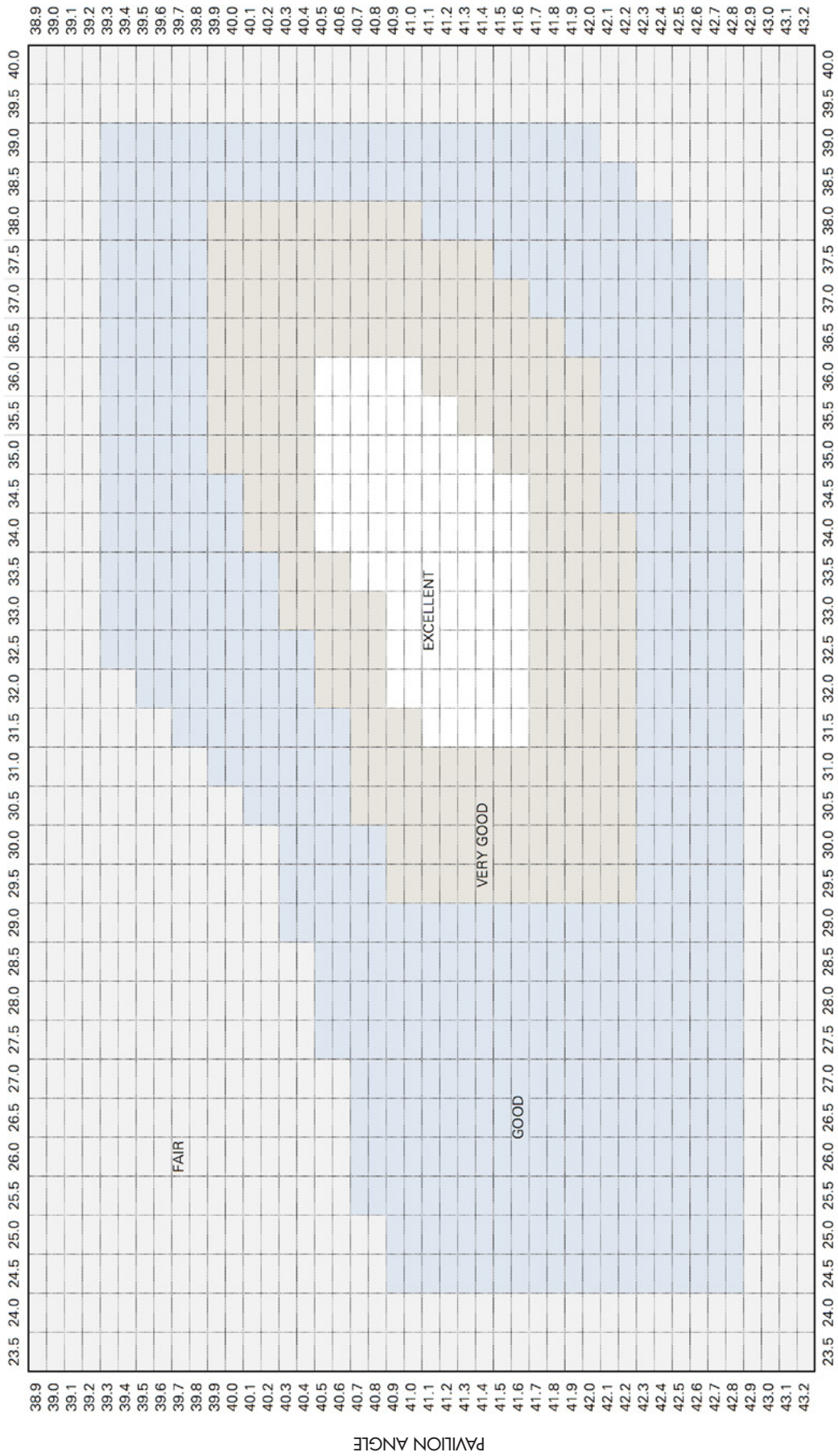

55 percent table

CROWN ANGLE

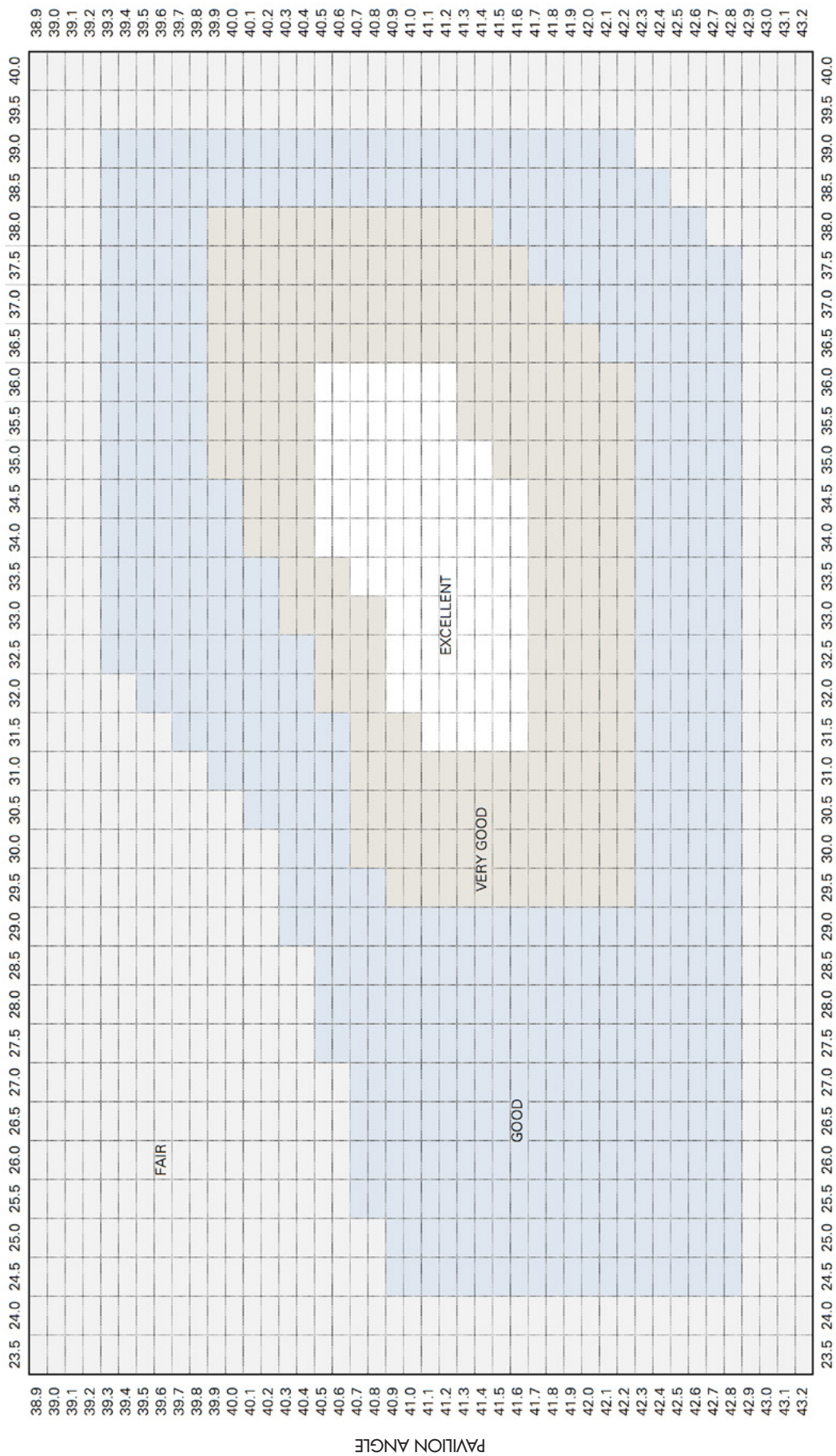

56 percent table

CROWN ANGLE

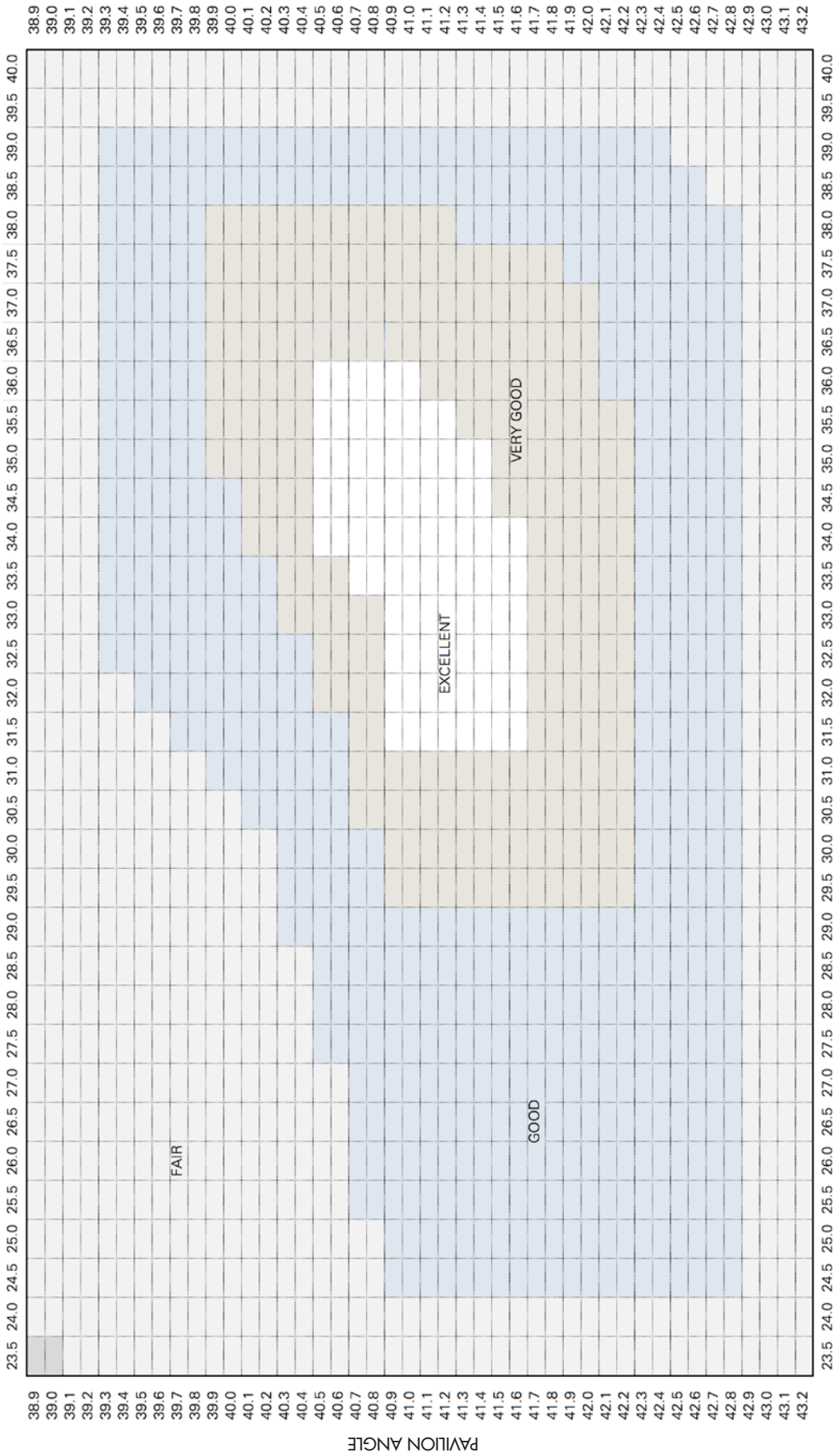

57 percent table

CROWN ANGLE

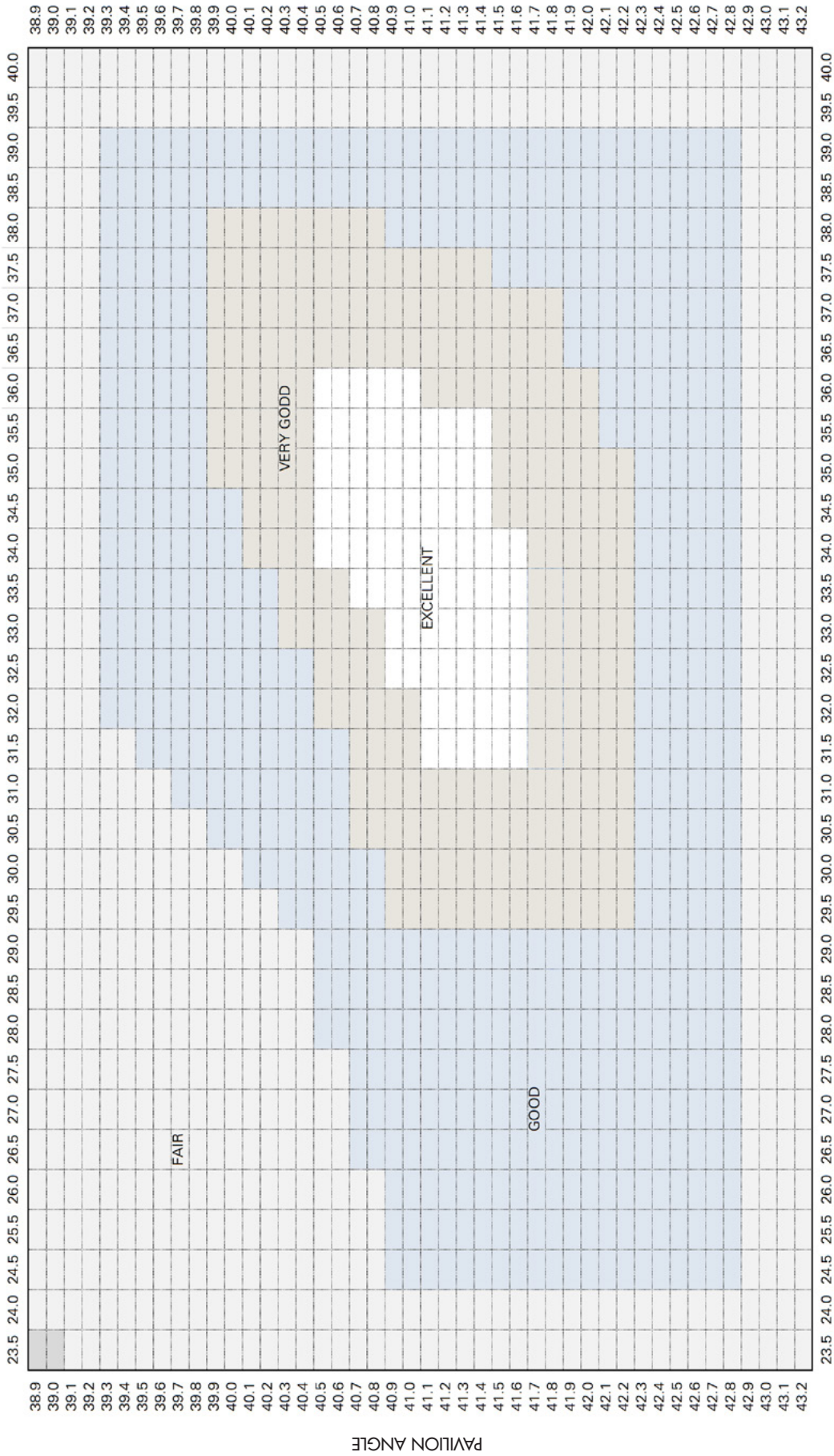

58 percent table

CROWN ANGLE

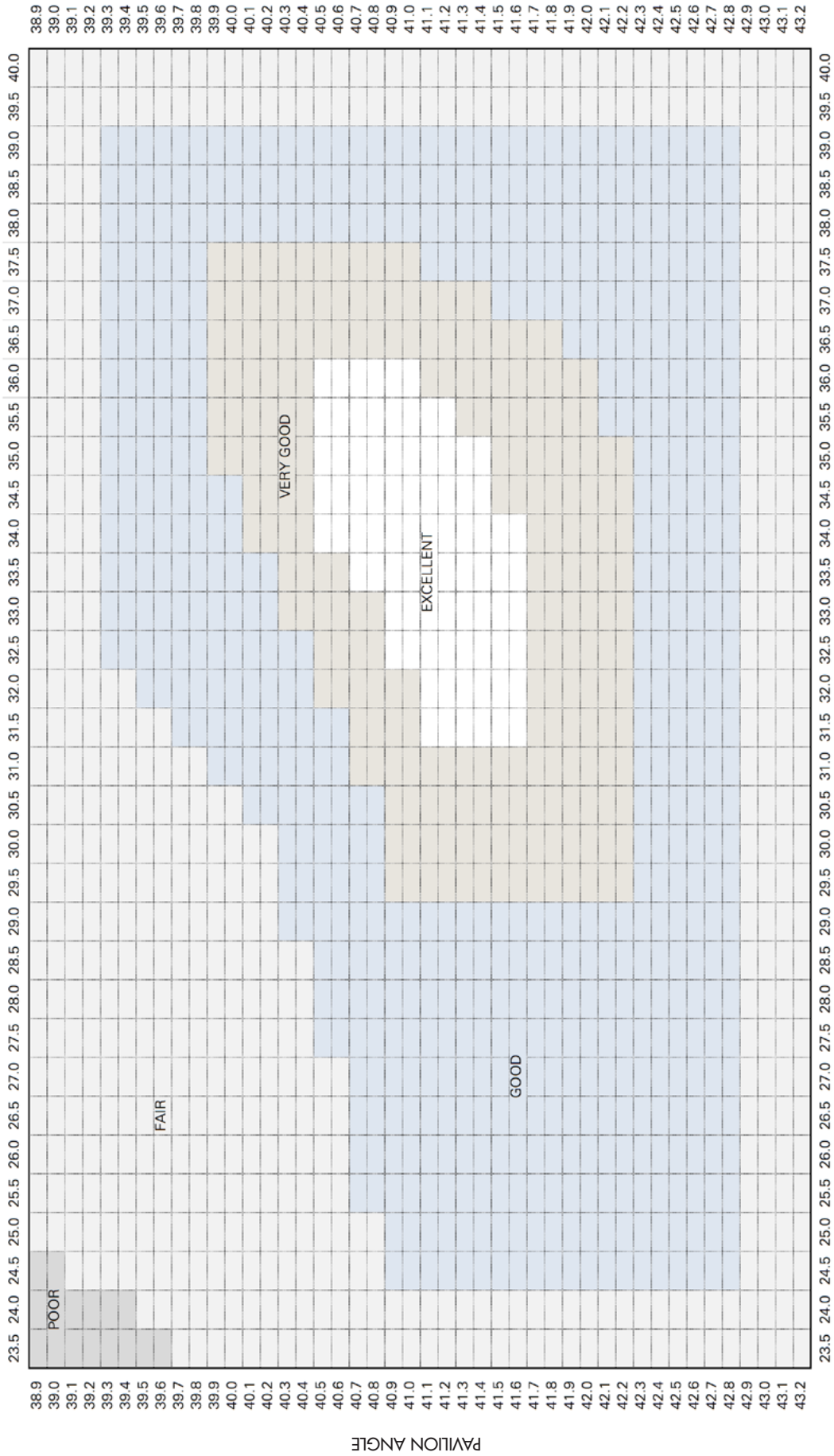

59 percent table

CROWN ANGLE

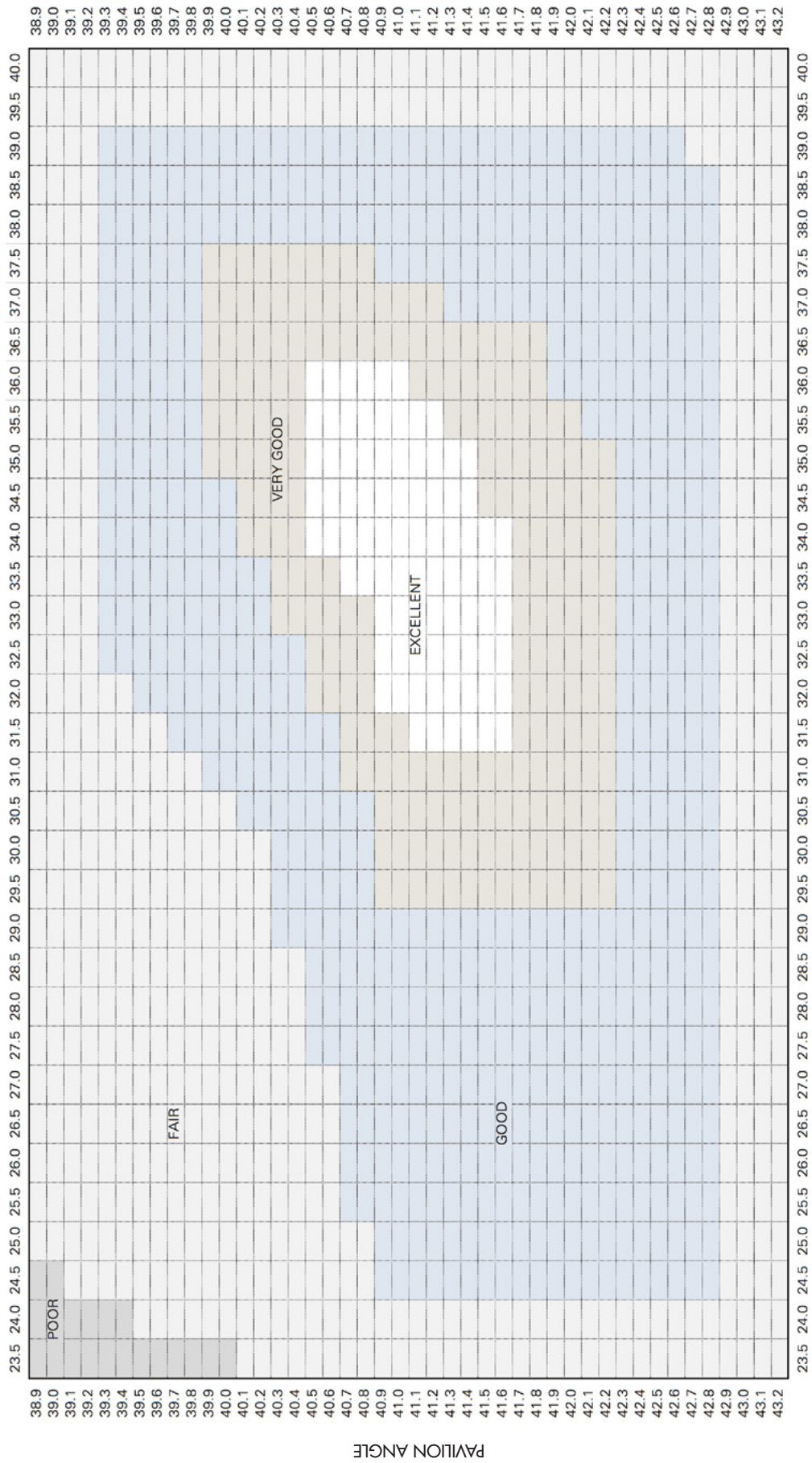

60 percent table

CROWN ANGLE

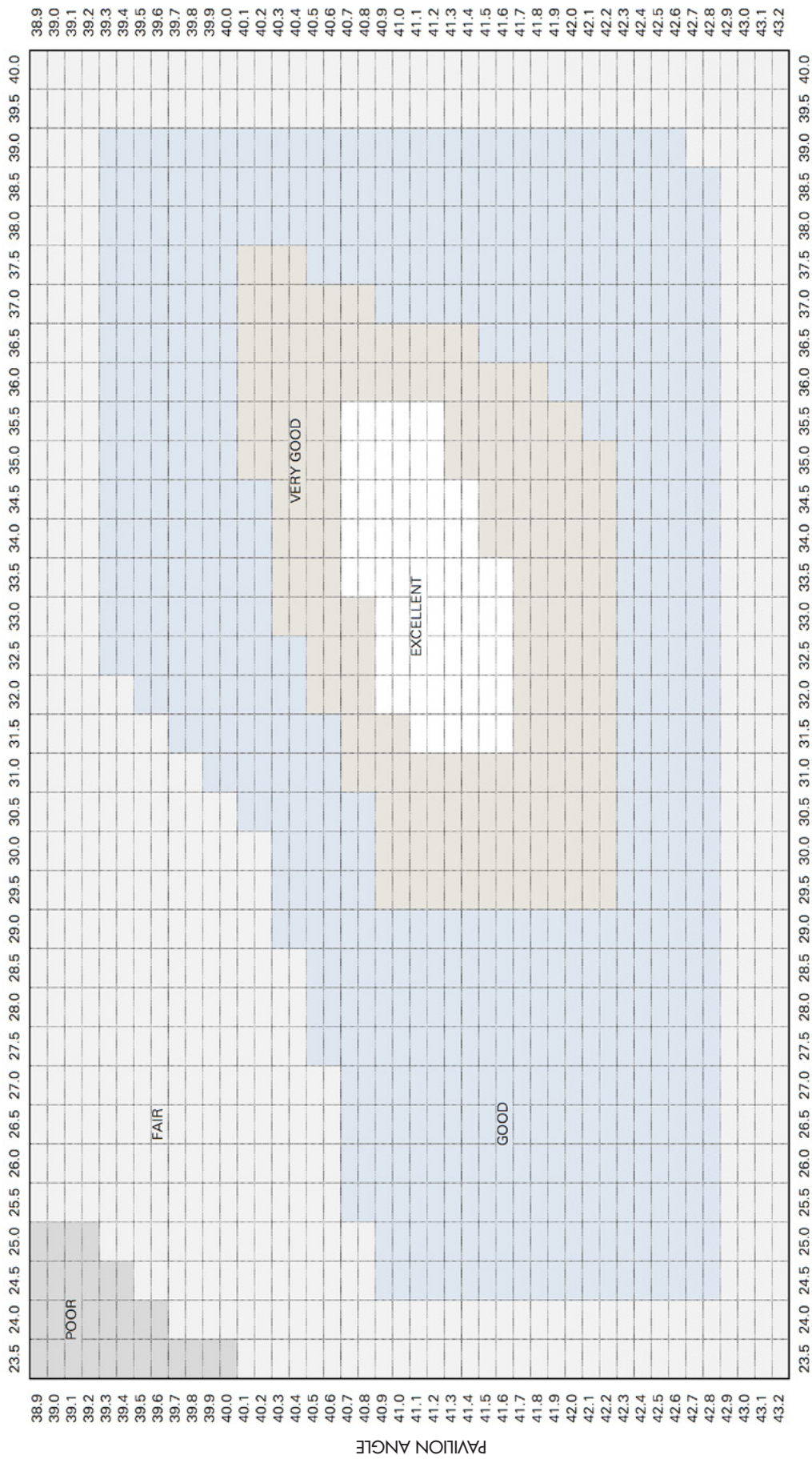

61 percent table

CROWN ANGLE

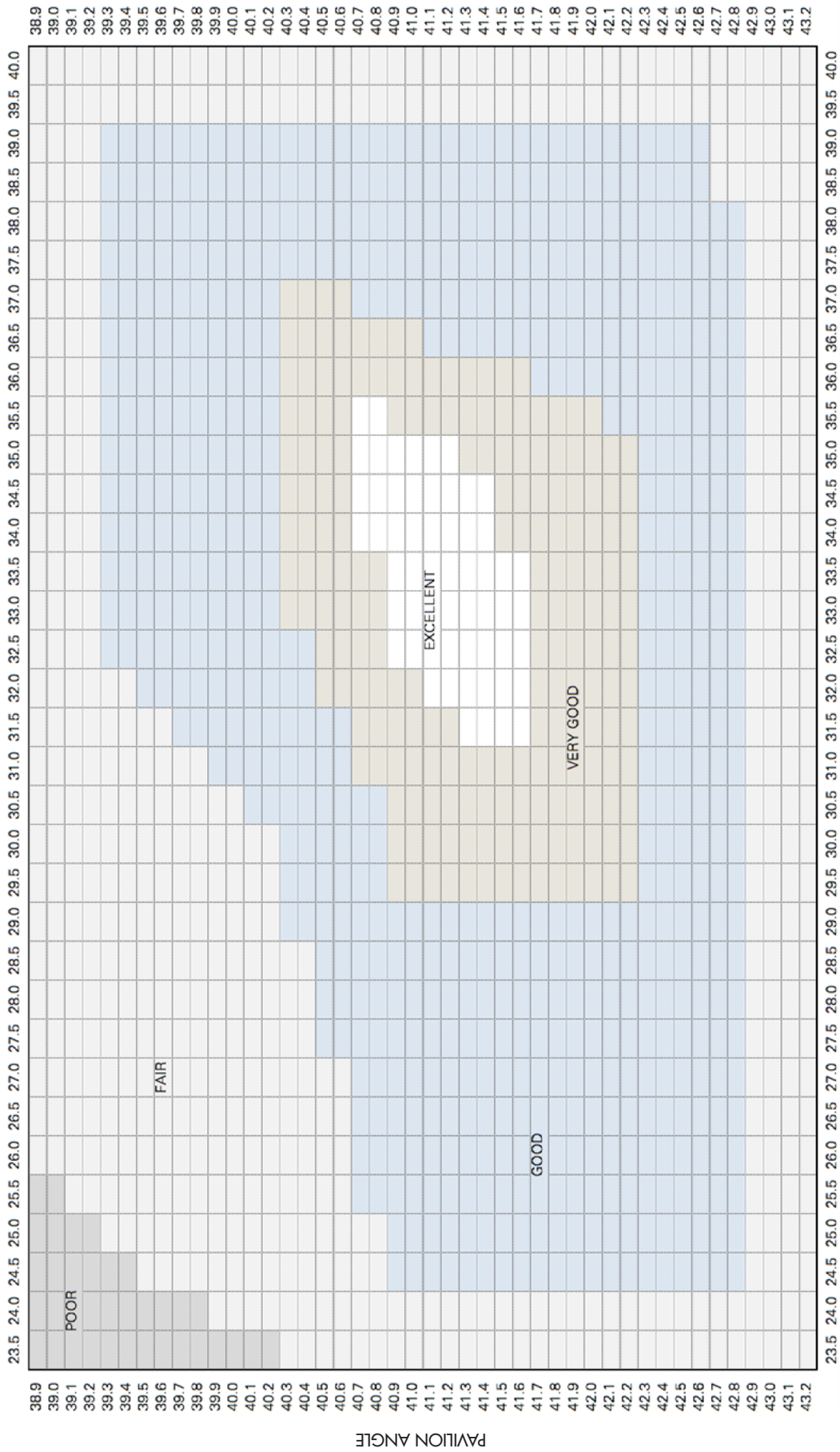

63 percent table

CROWN ANGLE

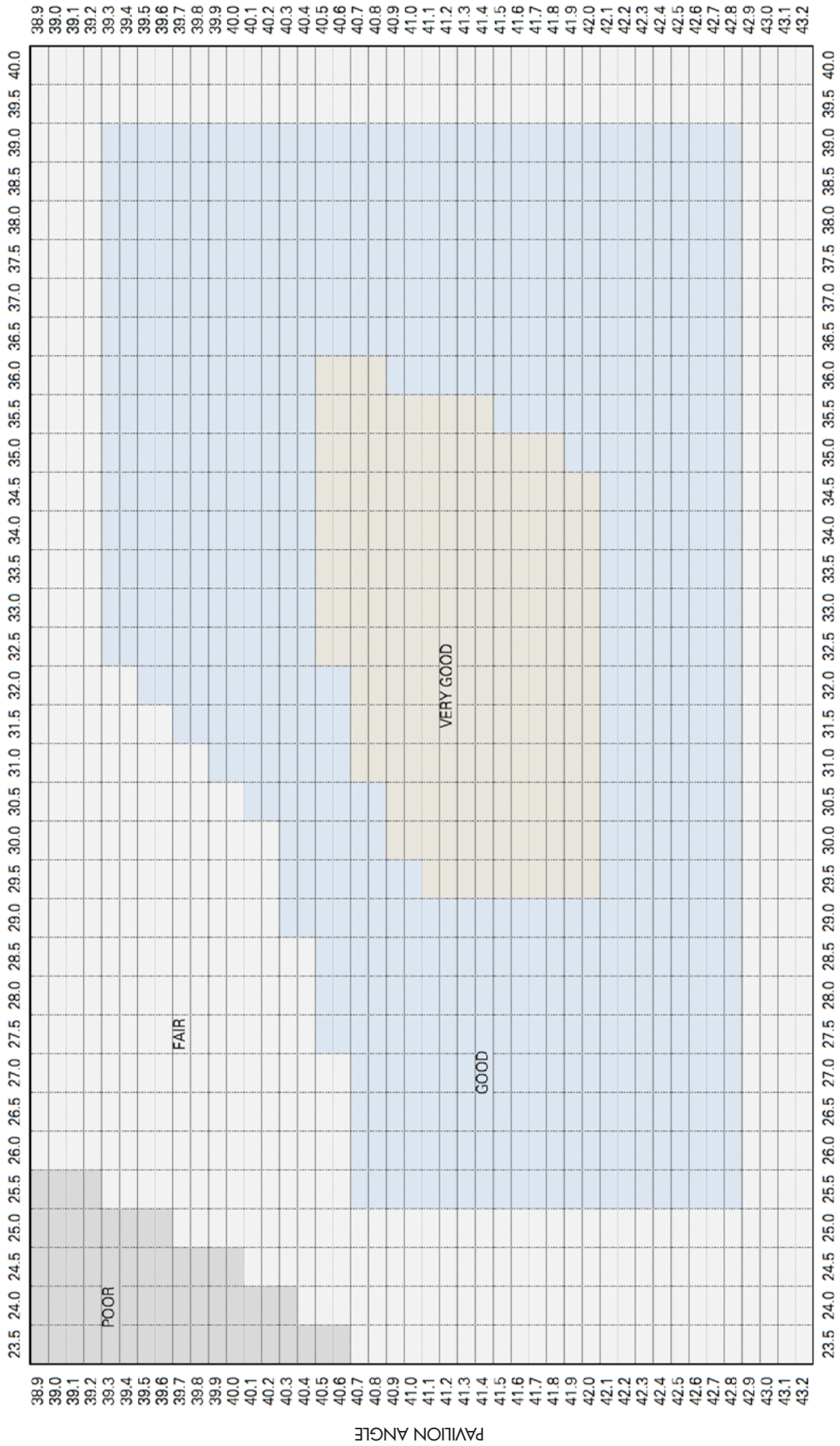

65 percent table

CROWN ANGLE

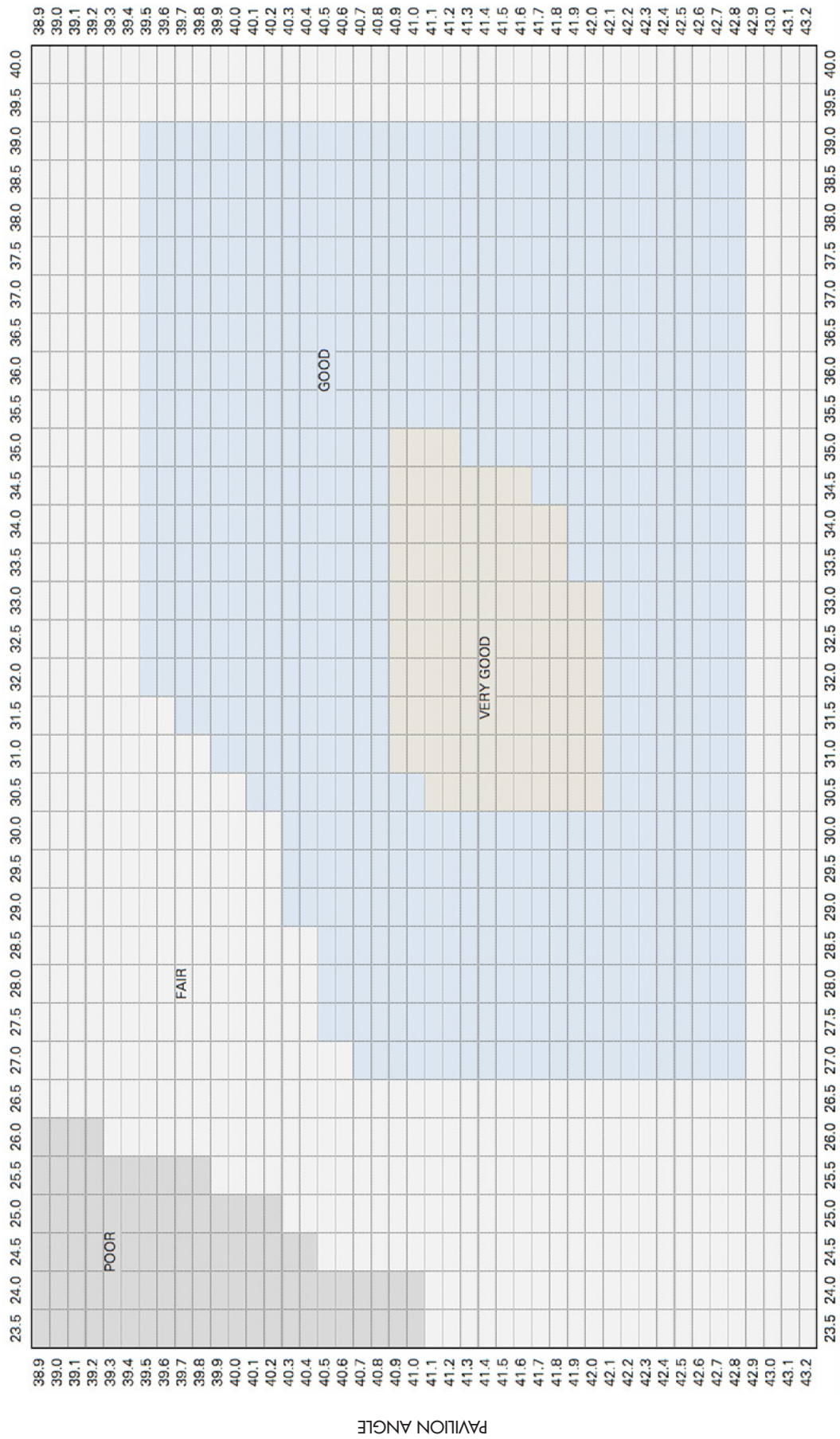

66 percent table

CROWN ANGLE

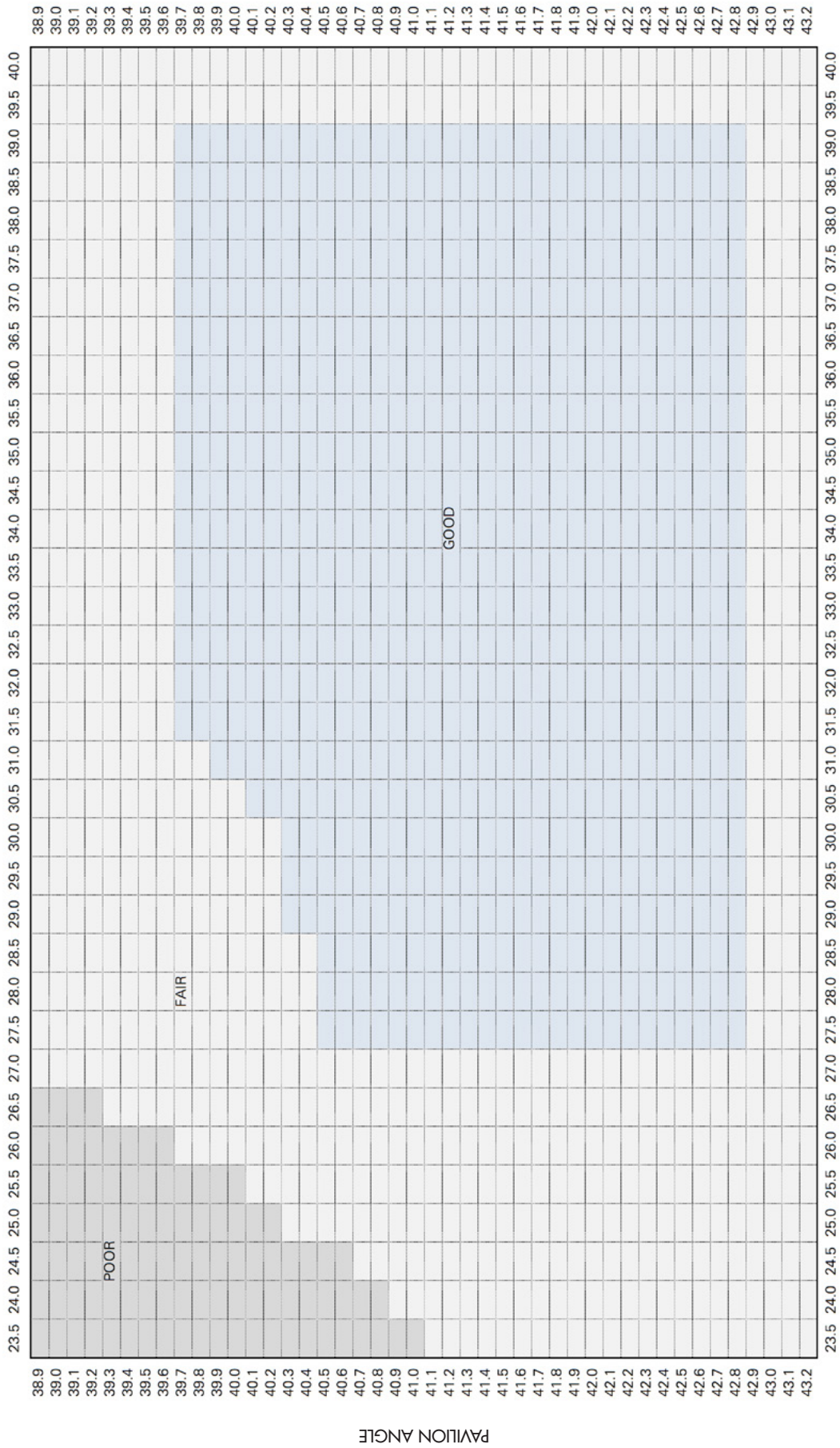

67, 68 and 69 percent table

CROWN ANGLE

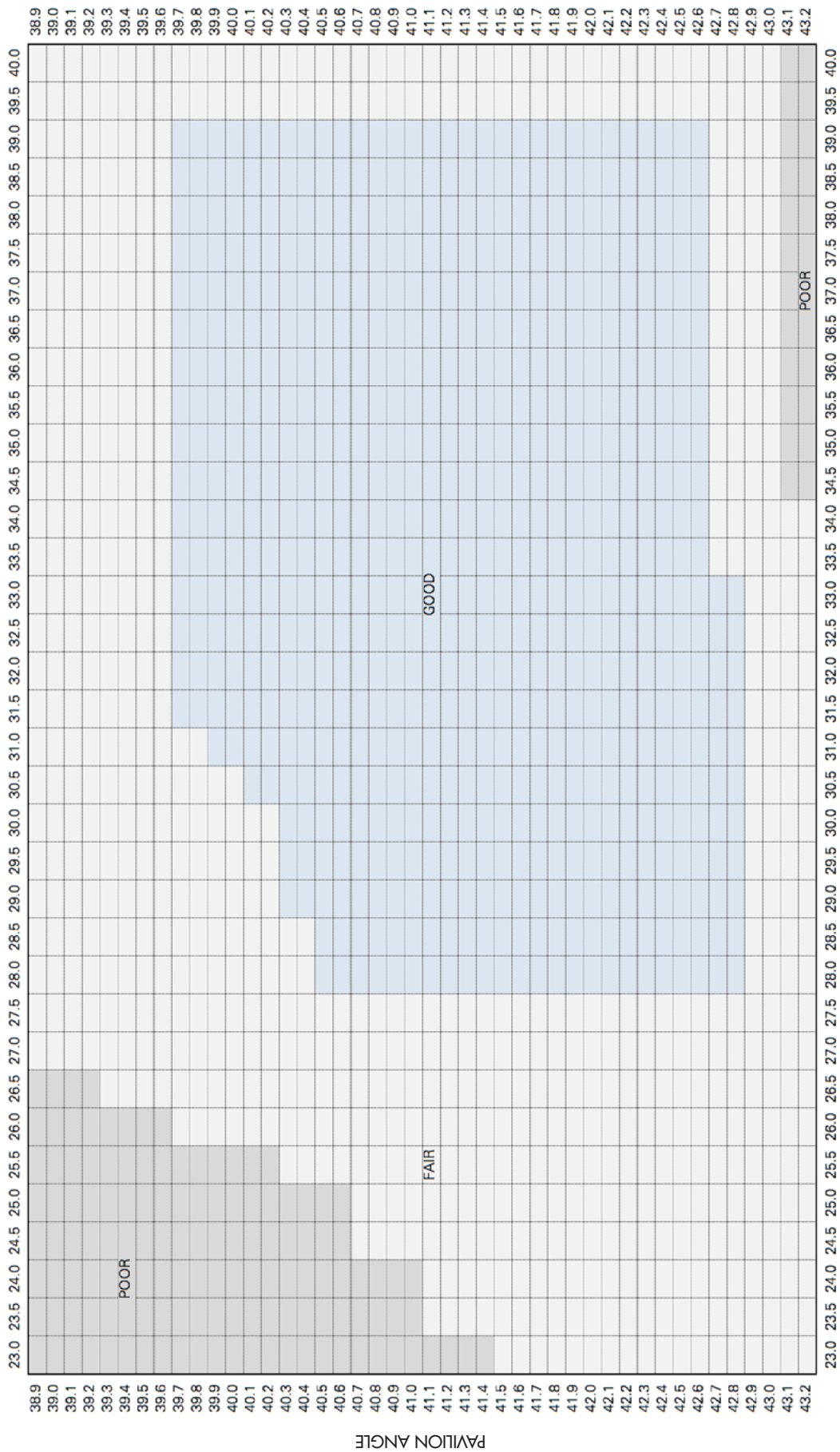

DE BEERS GROUP
INSTITUTE OF DIAMONDS

© 2015–2019 De Beers Group

De Beers Group Industry Services is a trading name of IIDGR (UK) Limited.

IIDGR (UK) Limited is a company incorporated in England and Wales with company number 08597754, whose registered office is at 20 Carlton House Terrace, London SW1Y 5AN, UK.